

TRUSTILE®
A MARVIN® BRAND

TRUSTILE WOOD ENTRY SYSTEMS
DESIGN THAT MOVES YOU™





See page B30 for product specs.

THE TRUSTILE STORY

Since 1995, TruStile has put design at the center of our products and processes. From the materials we select to our exacting craft and design, we engineer for quality that sets the tone for the whole home. In collaboration with our parent company, Marvin™, we have created a family of premium entry systems that don't just transform a space, but how you feel inside it. Make the entry to your new home a most welcoming invitation with an exceptional entrance by TruStile.

TRŪSTILE[®]
A MARVIN  BRAND

MARVIN 

EXCELLENCE
IN ENTRY
SYSTEMS

TRUSTILE WOOD ENTRY SYSTEMS

TABLE OF CONTENTS

- Wood Entry Systems 4
- TruStile Selection Guide 6
- Architectural Styles Overview 8
- Modern 10
- Traditional 22
- Modern Farmhouse 30
- French Country 36
- Coastal 42
- Mediterranean 48
- Craftsman 54
- Cape Cod 60
- Entry System Layouts 66
- Style Reference Guide 68
- Transom and Sidelite Options 76
- Construction and Acetylation 78
- Profile Options and Mull Construction 80
- Wood Species and Stain Options 82
- Hinge, Sill and Glass Options 84
- Entry Systems Comparison and Warranty 86
- Door Design Tool 88



TruStile Reserve™

System Code	TMF1000-103B
Layout	ES103
Door Style	TMF1000
Sidelite	DSG100
Wood Species	Mahogany
Finish	Ebony
Glass	White Lami

**Choose the Material
Best Suited for Your Project**

Both material construction options have been extensively tested and proven in partnership with the Marvin™ Research and Development team.



Resilient™ Wood Entry System

The Resilient Wood Entry System sets the tone of quality for the whole home using the most durable painted construction without sacrificing any design options.

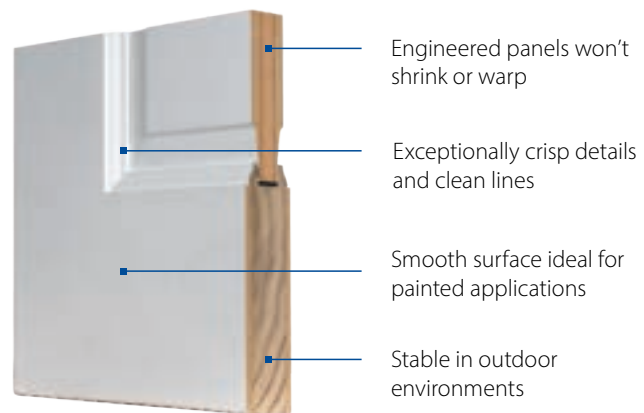

- Engineered with resilient Accoya®, an acetylated wood product, which brings unprecedented reliability and durability to wood.
- Tricoya® top layers provide exceptional stability, durability and paintability for outdoor applications.
- Most configurations delivered pre-hung with a premium prime finish that's ready to paint.
- 10-year warranty with limited and no overhang applications, depending on system design specifications.



Reserve™ Wood Entry System

The Reserve Wood Entry System elevates the refined elegance of your home with the beauty of stained natural wood.

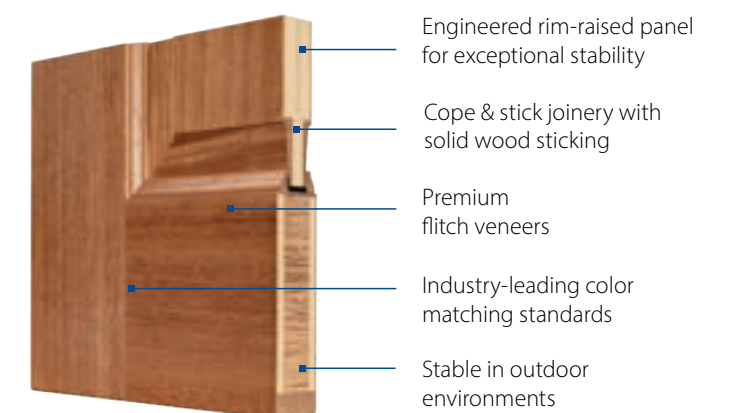

- 10 natural wood species available with an extensive collection of premium factory stain options.
- Premium appearance standards ensure industry-leading grain and color matching.
- Engineered with a laminated veneer lumber (LVL) core and Tricoya® layers for exceptional stability and durability.
- 5-year limited warranty with industry standard overhang requirements.

TRUSTILE ENTRY SYSTEMS

**TWO WAYS TO
CREATE YOUR
ENTRY SYSTEM**

Start designing at
www.trustile.com/designtool
Details on page 88.

Select From Our Featured Entry Systems

We've created over 80 featured entry systems that capture the current trends of popular architectural styles. Start with the style most closely matching your vision for your home and tailor it to match your tastes and requirements.

Or Build Your Own Entry System

Design your custom entry system in a few simple steps. Choose the right material for your project. Select from over 500 door styles and endless design options. Then finalize the details to your exact specifications.

Select From Over 80 Featured Entry Systems

See all options in each architectural section starting on page 8.

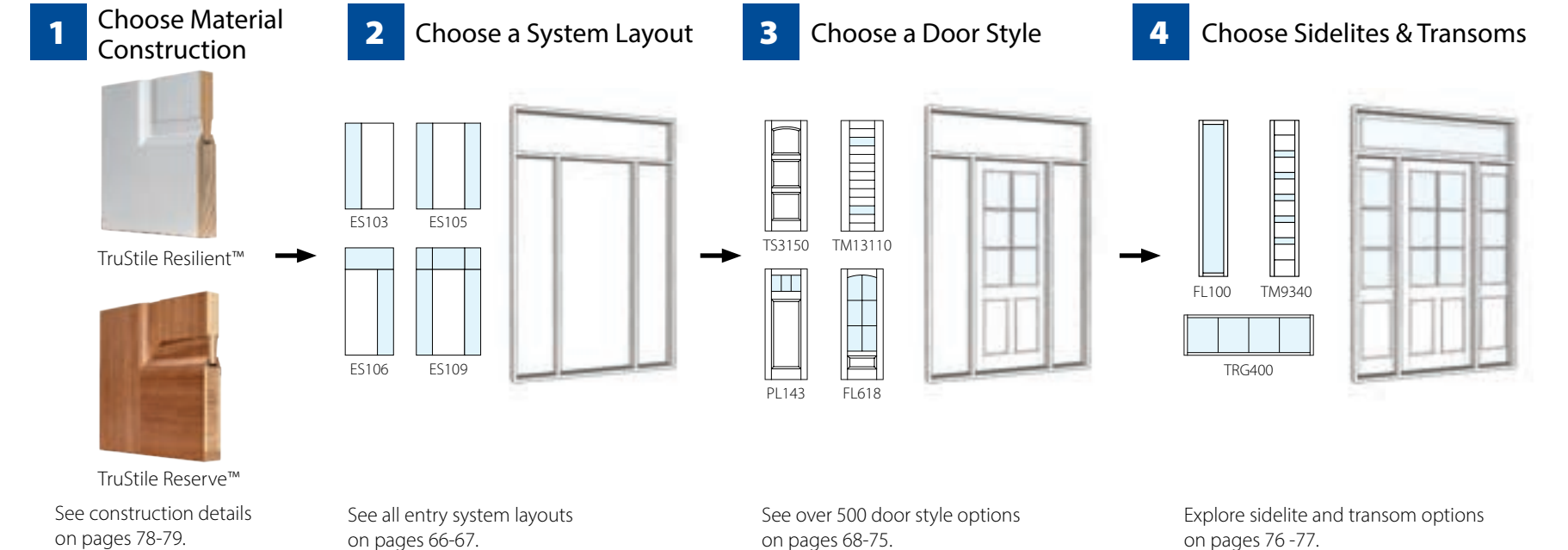
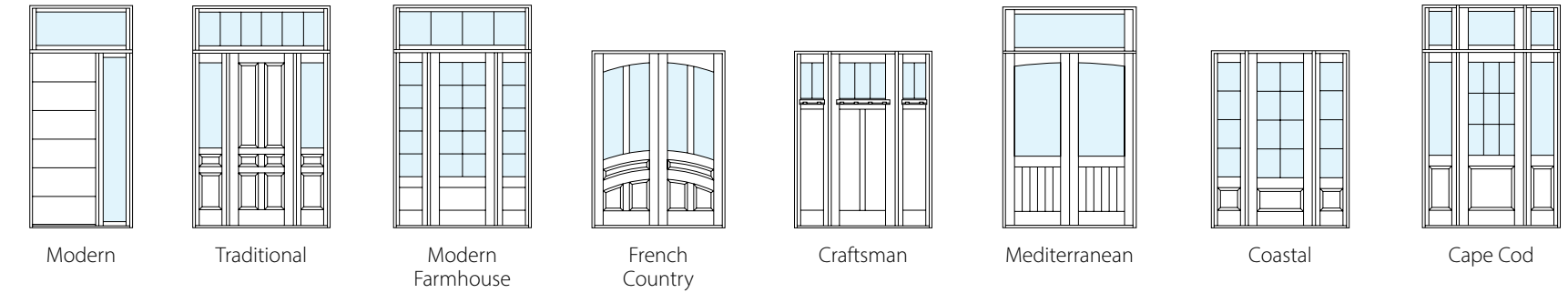



MODERN



TRADITIONAL



MODERN FARMHOUSE



FRENCH COUNTRY



COASTAL*



MEDITERRANEAN



CRAFTSMAN



CAPE COD

ARCHITECTURAL STYLES

IMPACTFUL
SOPHISTICATED
AUTHENTIC

TruStile has curated over 80 featured designs across eight architectural styles to make it easy to find the right look for your new entrance.

** Architectural category only. Impact and hurricane ratings not currently available. See your TruStile dealer to verify compatibility with your local building code.*

Wood is a natural product and the finish and color will vary depending on the wood species and lighting on the job site. The images printed within this catalog are a representation of TruStile species and stain colors and do not replace seeing the stain and wood samples in person. Please visit your local TruStile dealer to request a factory finished stain sample.



MODERN

SLEEK
CONTEMPORARY
STRIKING

TruStile Reserve™

System Code	TMIR6001-102B
Layout	ES102
Door Style	TMIR6001
Sidelite	DSG100
Profile	¼" Kerf Cut Reveal
Wood Species	Mahogany
Finish	White Haze
Glass	Clear

Reverse configuration shown with right handing.

MODERN

TruStile Resilient™

System Code	TM3100-111B
Layout	ES111
Door Style	TM3100
Sidelite	DSG100
Transom	DSG100
Profile	SS Sticking
Wood Species	Resilient Wood
Finish	SW 7069 Iron Ore
Glass	Clear

MODERN

TruStile Reserve™

System Code	TMIR9001-108A
Layout	ES108
Door Style	TMIR9001
Sidelite	FL100
Transom	TRG100
Profile	¼" Kerf Cut Reveal
Wood Species	Mahogany
Finish	Slate
Glass	Clear

MODERN



TruStile Reserve™

System Code	TM9340-105C
Layout	ES105
Door Style	TM9340
Sidelite	TM9340
Profile	¼" Kerf Cut Reveal
Wood Species	Rift Sawn White Oak
Finish	Grey Mist
Glass	White Lami

MODERN



TruStile Reserve™

System Code	TMIR1002-102B
Layout	ES102
Door Style	TMIR1002
Sidelite	DSG100
Profile	¼" Kerf Cut Reveal
Wood Species	Walnut
Finish	Ebony
Glass	Clear



TruStile Reserve™

System Code	TM6100-105A
Layout	ES105
Door Style	TM6100
Sidelite	TM1000
Profile	SS Sticking
Wood Species	Rift Sawn White Oak
Finish	White Haze
Glass	Clear

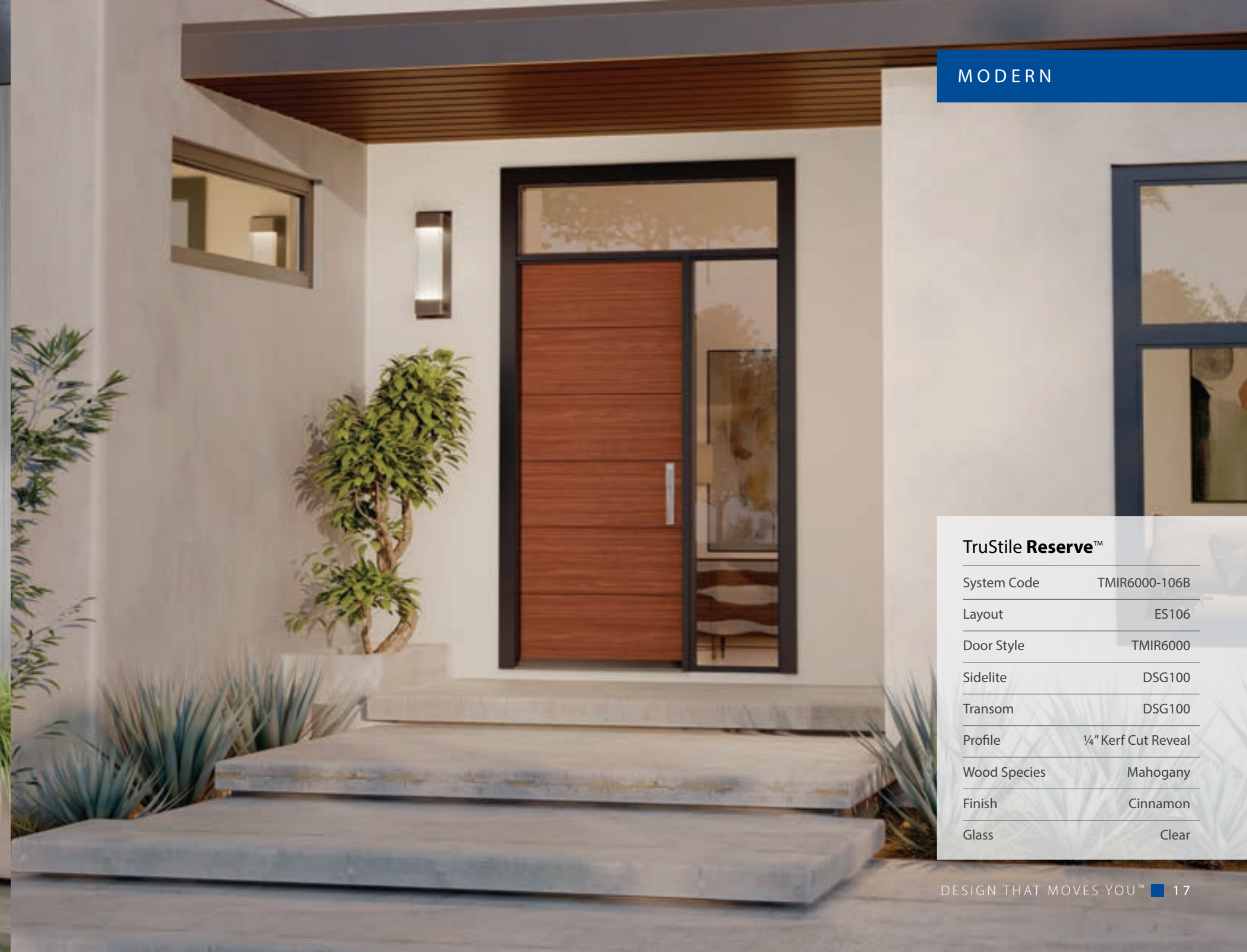

TruStile Reserve™

System Code	TMIR6000-106B
Layout	ES106
Door Style	TMIR6000
Sidelite	DSG100
Transom	DSG100
Profile	¼" Kerf Cut Reveal
Wood Species	Mahogany
Finish	Cinnamon
Glass	Clear



TruStile Resilient™

System Code	TMIR4000-108A
Layout	ES108
Door Style	TMIR4000
Sidelite	FL100
Transom	FL100
Profile	1/4" Kerf Cut Reveal
Wood Species	Resilient Wood
Finish	SW 2735 Rockweed
Glass	Clear



TruStile Reserve™

System Code	TMF1000-103A
Layout	ES103
Door Style	TMF1000
Sidelite	FL100
Wood Species	Plain Sawn White Oak
Finish	Nutmeg
Glass	Clear



TruStile Reserve™

System Code	TM9350-105A
Layout	ES105
Door Style	TM9350
Sidelite	FL100
Profile	¼" Kerf Cut Reveal
Wood Species	Walnut
Finish	Ebony
Glass	Clear

Choose One of Our **Featured Entry Systems**

Designed by TruStile and ready to order through your local dealer.

Featured Modern Entry Systems in this Catalog

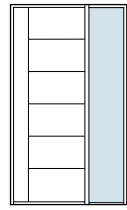
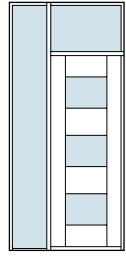
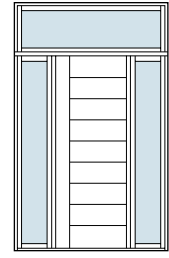
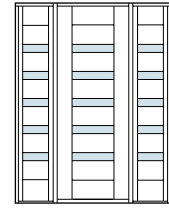
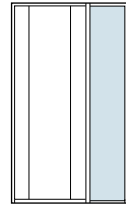
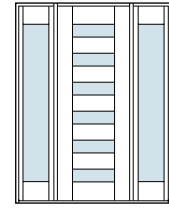
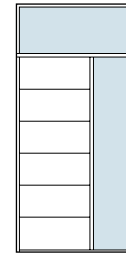
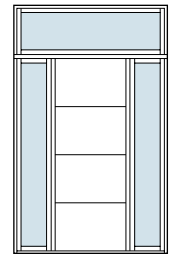
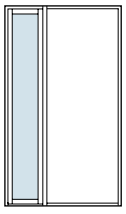
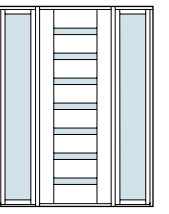
 TMIR6001-102B <i>pg 10</i>	 TM3100-111B <i>pg 12</i>	 TMIR9001-108A <i>pg 13</i>	
 TM9340-105C <i>pg 14</i>	 TMIR1002-102B <i>pg 15</i>	 TM6100-105A <i>pg 16</i>	 TMIR6000-106B <i>pg 17</i>
 TMIR4000-108A <i>pg 18</i>	 TMF1000-103A <i>pg 19</i>	 TM9350-105A <i>pg 20</i>	

Other Featured Modern Entry Systems

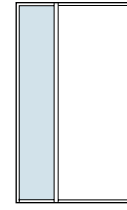
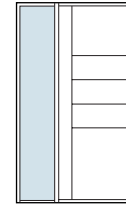
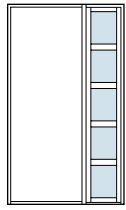
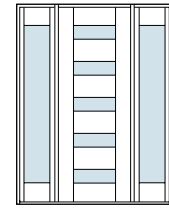
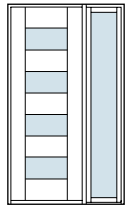
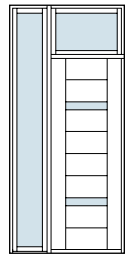
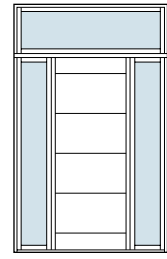
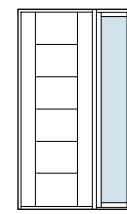
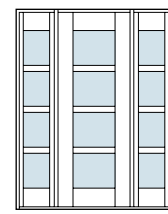
 TMF1000-103B <i>pg 2</i>	 TMIR5101-103B <i>pg 68</i>	 TMF1000-102D <i>online</i>	
 TM5100-105A <i>online</i>	 TM9160-102A <i>online</i>	 TM9310-111A <i>online</i>	 TMIR6080-108A <i>online</i>
 TM6001-ES102A <i>online</i>	 TM4000-105C <i>online</i>	 TM9000-108A <i>online</i>	

See more door style options on pages 68-75.



TRADITIONAL

CLASSIC
POLISHED
TIMELESS

TruStile Resilient™

System Code	TS3070-204A
Layout	ES204
Door Style	TS3070
Transom	FL100
Profile	QB Sticking/B Panel
Wood Species	Resilient Wood
Finish	SW 7069 Iron Ore
Glass	Clear

TRADITIONAL



TruStile Reserve™

System Code	TS3000-109D
Layout	ES109
Door Style	TS3000
Sidelite	FL300
Transom	TRG100
Profile	QB Sticking/B Panel
Wood Species	Mahogany
Finish	Nutmeg
Glass	Clear

TRADITIONAL



TruStile Reserve™

System Code	FL616-109C
Layout	ES109
Door Style	FL616
Sidelite	FL310
Transoms	TRG100 and TRG200
Profile	SS Sticking/C Panel
Wood Species	Plain Sawn White Oak
Finish	Hazelnut
Glass	Clear



TRADITIONAL

TruStile Reserve™

System Code	TS6020-108D
Layout	ES108
Door Style	TS6020
Sidelite	TS3070
Transom	TRG600
Profile	OG Sticking/D Panel
Wood Species	Mahogany
Finish	Ebony
Glass	Clear



TRADITIONAL

TruStile Resilient™

System Code	TS3100-109C
Layout	ES109
Door Style	TS3100
Sidelite	FL110
Transom	TRG100
Profile	OS Sticking/A Panel
Wood Species	Resilient Wood
Finish	SW 6990 Caviar
Glass	Clear



TruStile Reserve™

System Code	TS4060-504A
Layout	ES504
Door Style	TS4060
Transom	TRG110
Profile	CB Sticking/B Panel
Wood Species	Mahogany
Finish	Cinnamon
Glass	Clear

Choose One of Our **Featured Entry Systems**

Designed by TruStile and ready to order through your local dealer.

Featured Traditional Entry Systems in this Catalog

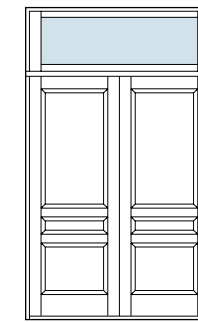

TS3070-204A
pg 22

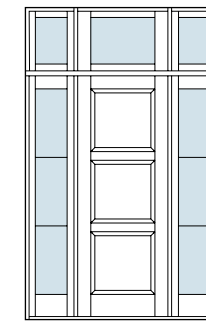

TS3000-109D
pg 24



FL616-109C
pg 25

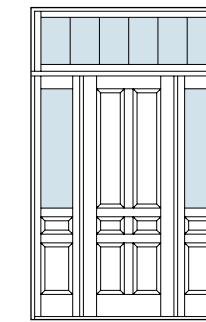

TS6020-108D
pg 26

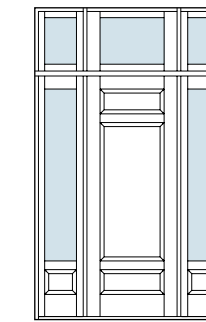

TS3100-109C
pg 27

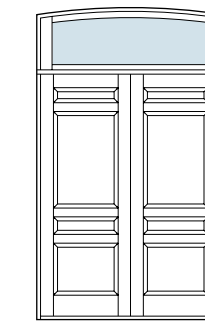

TS4060-504A
pg 28

Other Featured Traditional Entry Systems

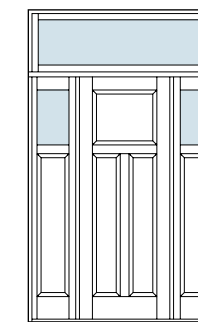

TS3300-108C
online

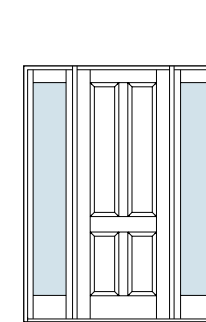

TS4000-105A
online

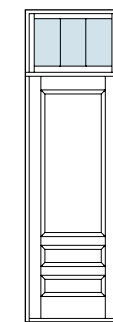

TS3280-104D
online

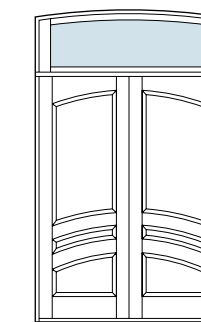

TS3160-504A
online

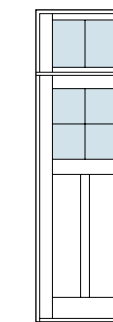

PL234-104C
online

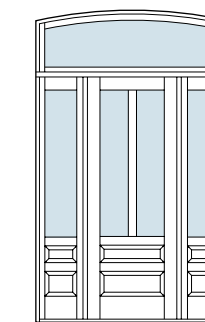

TS4300-308C
pg 76

See more door style options on pages 68-75.



MODERN FARMHOUSE

FRESH RELAXED UPDATED

TruStile Resilient™

System Code	FL400-108C
Layout	ES108
Door Style	FL400
Sidelite	FL400
Transom	TRG400
Profile	BV Sticking
Wood Species	Resilient Wood
Finish	SW 9130 Evergreen Fog
Glass	Clear



TruStile Reserve™

System Code	FL1001-108C
Layout	ES108
Door Style	FL1001
Sidelite	FL501
Transom	TRG400
Profile	BV Sticking/C Panel
Wood Species	Quarter Sawn White Oak
Finish	Grey Mist
Glass	Clear



TruStile Reserve™

System Code	PL104-205C
Layout	ES205
Door Style	PL104
Sidelite	PL102
Profile	SS Sticking/C Panel
Wood Species	Plain Sawn White Oak
Finish	Grey Mist
Glass	Clear

Choose One of Our **Featured Entry Systems**

Designed by TruStile and ready to order through your local dealer.



TruStile Reserve™

System Code	PL106-204A
Layout	ES204
Door Style	PL106
Transom	TRG100
Profile	SS Sticking/C Panel
Wood Species	Walnut
Finish	Amaretto
Glass	Clear

Featured Modern Farmhouse Entry Systems in this Catalog

Other Featured Modern Farmhouse Entry Systems

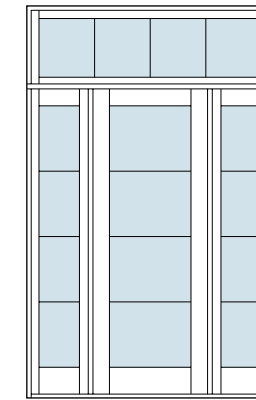

FL400-108C
pg 30

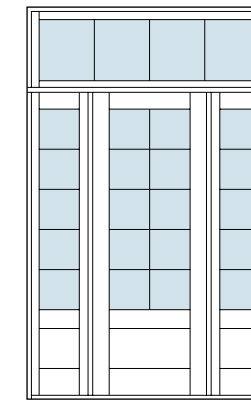

FL1001-108C
pg 32

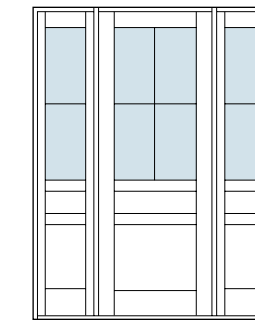

PL224-105C
online

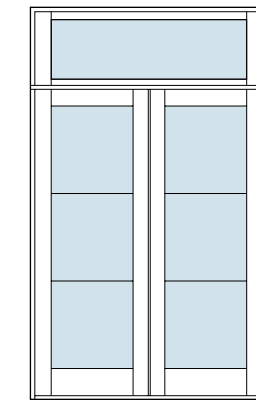

FL300-204A
online

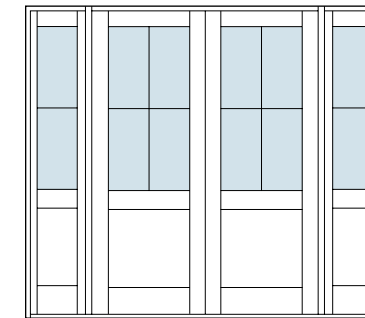

PL104-205C
pg 33

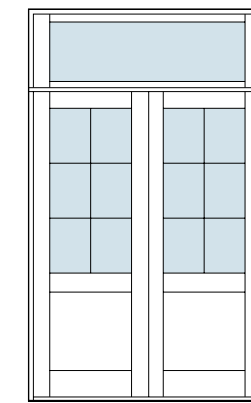

PL106-204A
pg 34

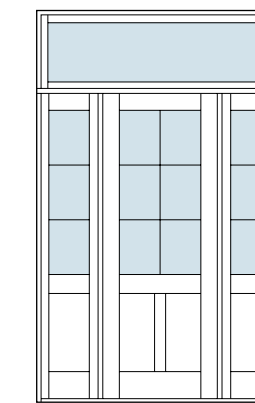

PL206-108C
online

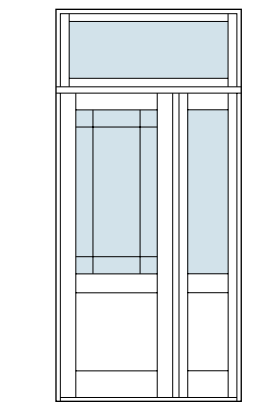

PL119-106D
online

See more door style options on pages 68-75.



FRENCH COUNTRY

ORNATE
CHARMING
ELEGANT

TruStile Reserve™

System Code	TS5030-108D
Layout	ES108
Door Style	TS5030
Sidelite	FL110
Transom	TRG100
Profile	BV Sticking/A Panel
Wood Species	Walnut
Finish	Clear
Glass	Clear



FRENCH COUNTRY

TruStile Resilient™

System Code	TS3160-201
Layout	ES201
Door Style	TS3160 (Common Arch Pair)
Profile	OG Sticking/B Panel
Wood Species	Resilient Wood
Finish	SW 6227 Meditative



FRENCH COUNTRY

TruStile Reserve™

System Code	TS4200-105C
Layout	ES105
Door Style	TS4200
Sidelite	TS3130
Profile	OG Sticking/B Panel
Wood Species	Mahogany
Finish	Caramel
Glass	Clear

Choose One of Our **Featured Entry Systems**

Designed by TruStile and ready to order through your local dealer.



TruStile Resilient™

System Code	TS5020-201
Layout	ES201
Door Style	TS5020 (Common Arch Pair)
Profile	OG Sticking/B Panel
Wood Species	Resilient Wood
Finish	SW 9580 Cracked Pepper
Glass	Beveled

Featured French Country Entry Systems in this Catalog

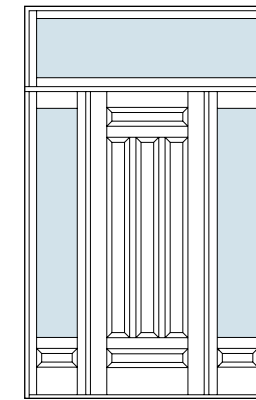

TS5030-108D
pg 36

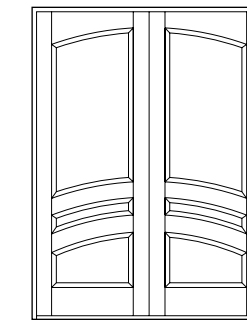

TS3160-201
pg 38

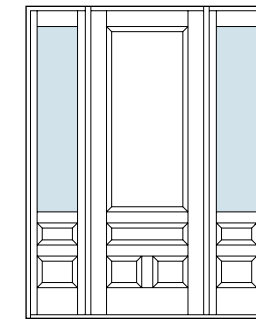

TS4200-105C
pg 39

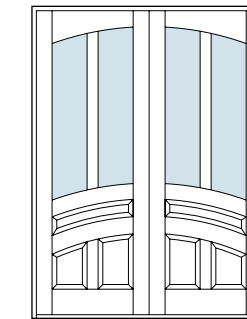

TS5020-201
pg 40

Other Featured French Country Entry Systems

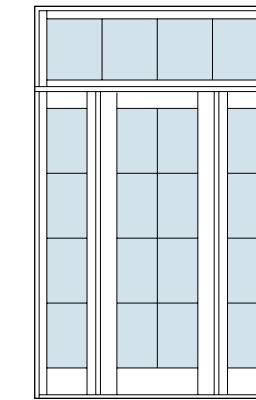

FL800-108C
online

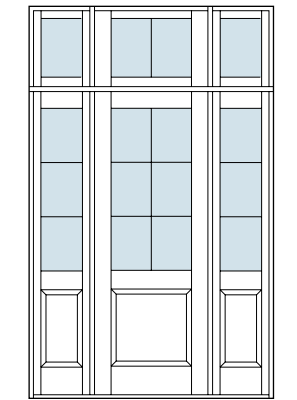

PL106-109C
online



PL109-102C
online

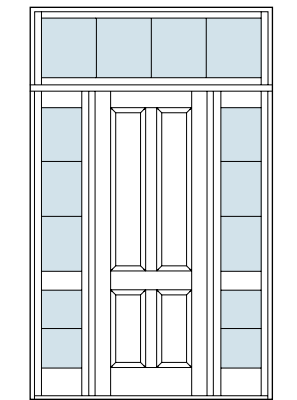

TS4000-108D
online

See more door style options on pages 68-75.



COASTAL*

BREEZY

WELCOMING

CASUAL

TruStile Reserve™

System Code	FL810-105C
Layout	ES105
Door Style	FL810
Sidelite	FL401
Profile	OG Sticking/B Panel
Wood Species	Mahogany
Finish	White Haze
Glass	Clear

* Architectural category only. Impact and hurricane ratings not currently available. See your TruStile dealer to verify compatibility with your local building code.



TruStile Reserve™

System Code	TMP1000-107B
Layout	ES107
Door Style	TMP1000
Sidelite	DSG100
Transom	DSG100
Profile	1/4" Kerf Cut Reveal
Wood Species	Rift Sawn White Oak
Finish	White Haze
Glass	Clear



TruStile Reserve™

System Code	PL145-105C
Layout	ES105
Door Style	PL145
Sidelite	PL145
Profile	SS Sticking/VG Panel
Wood Species	Walnut
Finish	Slate
Glass	Clear



TruStile Reserve™

System Code	TS3130-109C
Layout	ES109
Door Style	TS3130
Sidelite	TS3130
Transom	TRG100
Profile	SS Sticking/C Panel
Wood Species	Rift Sawn White Oak
Finish	Grey Mist
Glass	Clear

Choose One of Our **Featured Entry Systems**

Designed by TruStile and ready to order through your local dealer.

Featured Coastal Entry Systems in this Catalog

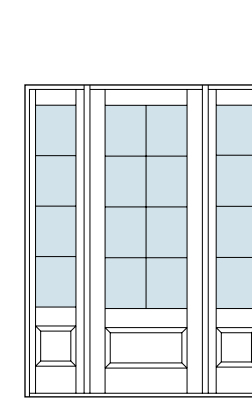

FL810-105C
pg 42

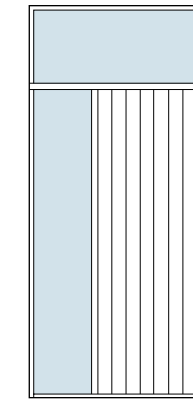

TMP1000-107B
pg 44

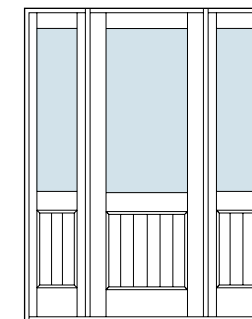

PL145-105C
pg 45



TS3130-109C
pg 46

Other Featured Coastal Entry Systems

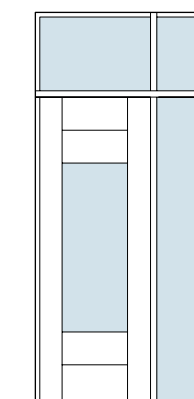

TM9250-115B
online

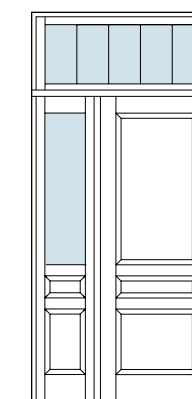

TS3070-106D
online

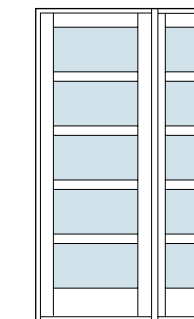

TS5000-102C
online

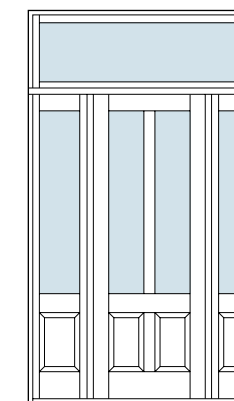

TS4140-108C
online

See more door style options on pages 68-75.



MEDITERRANEAN

WARM
VIBRANT
GRAND

TruStile Reserve™

System Code	PL145-201
Layout	ES201
Door Style	PL145
Profile	QB Sticking/VG Panel
Wood Species	Walnut
Finish	Clear
Glass	Clear



TruStile Reserve™

System Code	TS3130-201
Layout	ES201
Door Style	TS3130
Profile	BM Sticking/B Panel
Wood Species	Walnut
Finish	Slate

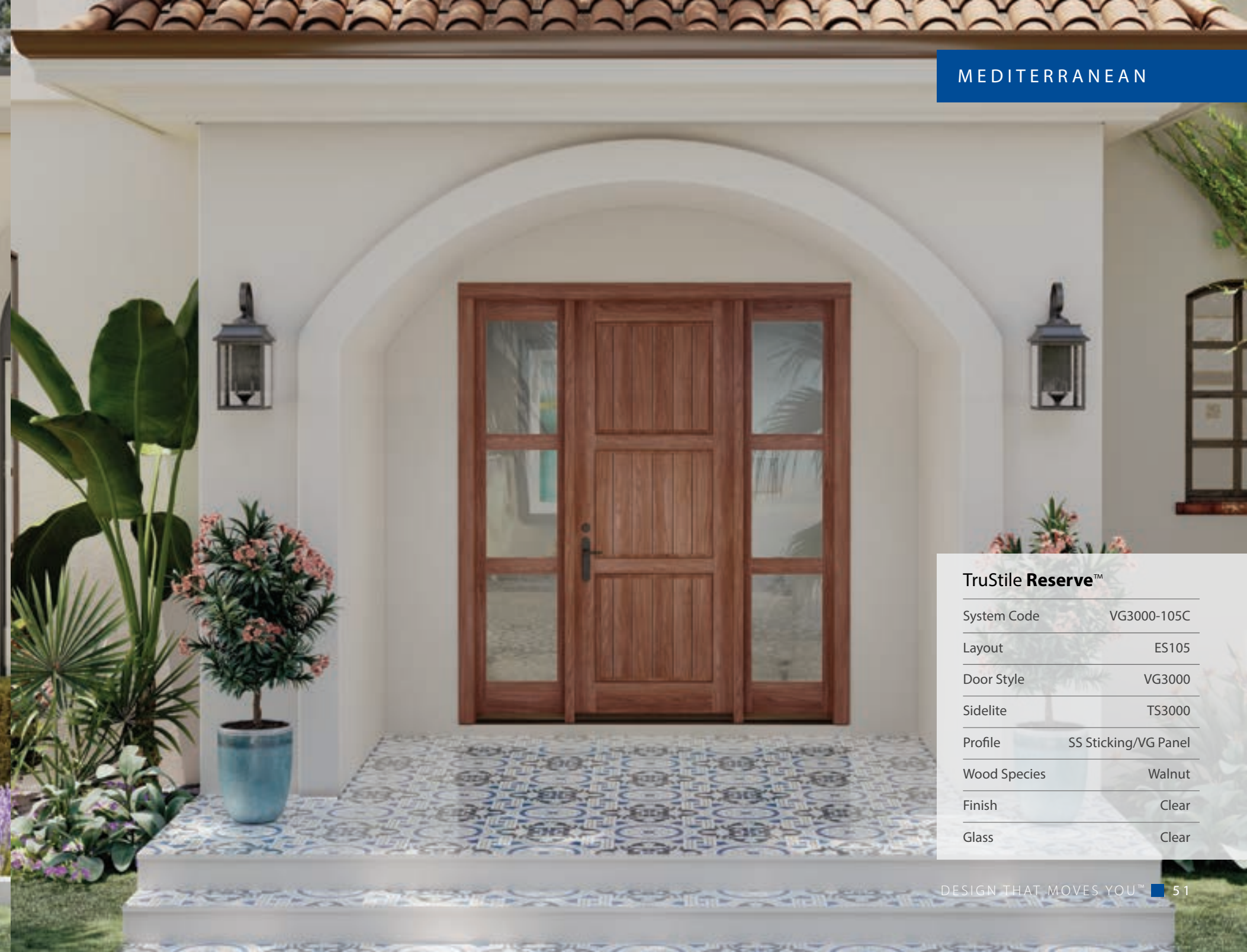

TruStile Reserve™

System Code	VG3000-105C
Layout	ES105
Door Style	VG3000
Sidelite	TS3000
Profile	SS Sticking/VG Panel
Wood Species	Walnut
Finish	Clear
Glass	Clear

Choose One of Our **Featured Entry Systems**

Designed by TruStile and ready to order through your local dealer.



TruStile Resilient™

System Code	VG1000-101
Layout	ES101
Door Style	VG1000
Profile	Standard V-Groove
Wood Species	Resilient Wood
Finish	SW 6328 Fireweed

Featured Mediterranean Entry Systems in this Catalog

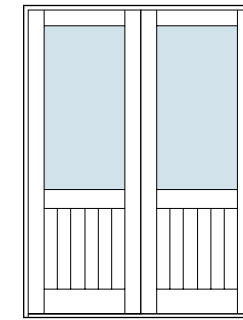

PL145-201
pg 48

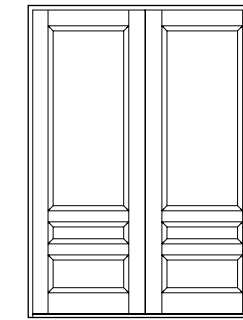

TS3130-201
pg 50

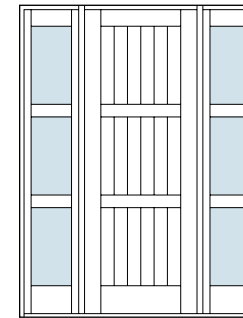

VG3000-105C
pg 51

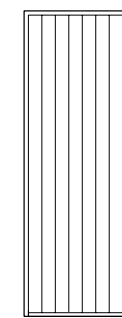

VG1000-101
pg 52

Other Featured Mediterranean Entry Systems

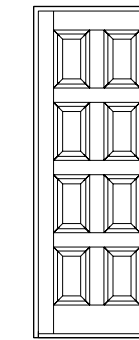

TS8000-101
online

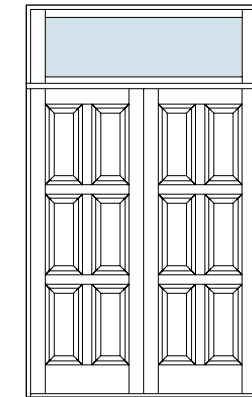

TS6080-105
online

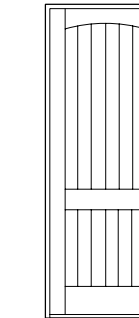

VG2020-101
online

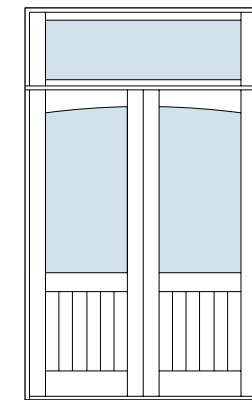

PL176-204A
online

See more door style options on pages 68-75.



CRAFTSMAN

AUTHENTIC

PRECISE

COMFORTING

TruStile Reserve™

System Code	PL333-105C
Layout	ES105
Door Style	PL333 (Small Dentil Bird Ledge)
Sidelite	PL130 (Small Dentil Bird Ledge)
Profile	SS Sticking/C Panel
Wood Species	Plain Sawn White Oak
Finish	Grey Mist
Glass	Clear



TruStile Reserve™

System Code	FL618-205C
Layout	ES205
Door Style	FL618 (Common Arch Pair)
Sidelite	FL315 (Common Arch Pair)
Profile	QR Sticking/B Panel
Wood Species	Mahogany
Finish	White Haze
Glass	Clear



TruStile Resilient™

System Code	PL236-109C
Layout	ES109
Door Style	PL236
Sidelite	PL104
Transoms	TRG200 and TRG300
Profile	SS Sticking/C Panel
Wood Species	Resilient Wood
Finish	SW 7006 Extra White
Glass	Clear

Choose One of Our **Featured Entry Systems**

Designed by TruStile and ready to order through your local dealer.

Featured Craftsman Entry Systems in this Catalog

Other Featured Craftsman Entry Systems

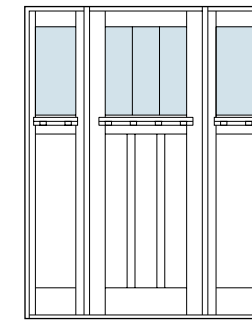

PL333-105C
pg 54

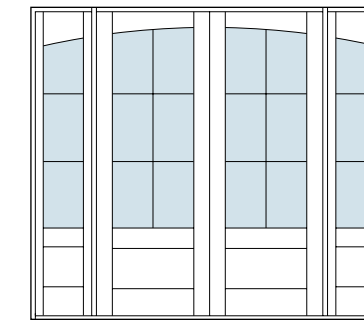

FL618-205C
pg 56

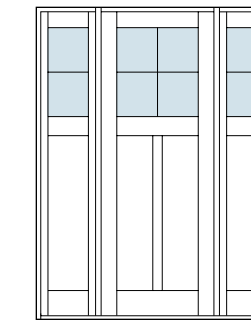

PL234-105C
online

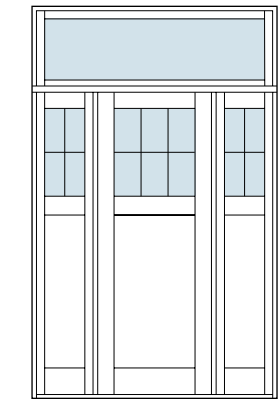

PL136-108C
online

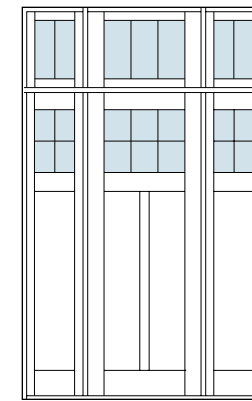

PL236-109C
pg 57

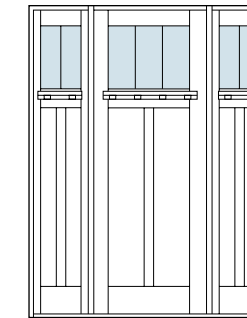

PL243-105C
pg 58

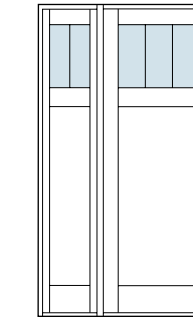

PL143-103C
online

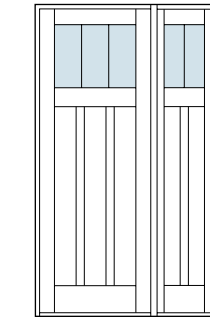

PL343-102C
online

TruStile Reserve™

System Code	PL243-105C
Layout	ES105
Door Style	PL243 (Small Dentil Bird Ledge)
Sidelite	PL232 (Small Dentil Bird Ledge)
Profile	SS Sticking/C Panel
Wood Species	Rift Sawn White Oak
Finish	Hazelnut
Glass	White Lami

See more door style options on pages 68-75.



CAPE COD

HISTORIC AMBITIOUS STATELY

TruStile Reserve™

System Code	PL224-109C
Layout	ES109
Door Style	PL224
Sidelite	PL222
Transoms	TRG100
Profile	OG Sticking/A Panel
Wood Species	Rift Sawn White Oak
Finish	Ebony
Glass	Clear

TruStile Reserve™

System Code	PL106-308C
Layout	ES308
Door Style	PL106
Sidelite	PL103
Transom	TRG110
Profile	QR Sticking/A Panel
Wood Species	Plain Sawn White Oak
Finish	Hazelnut
Glass	White Lami



TruStile Reserve™

System Code	TS2210-105C
Layout	ES105
Door Style	TS2210
Sidelite	TS2210
Profile	CB Sticking/B Panel
Wood Species	Walnut
Finish	Champagne
Glass	Clear



Choose One of Our **Featured Entry Systems**

Designed by TruStile and ready to order through your local dealer.



TruStile Resilient™

System Code	PL224-101
Layout	ES101
Door Style	PL224
Profile:	CB Sticking/A Panel
Wood Species	Resilient Wood
Finish	SW 0018 Teal Stencil
Glass	Clear

Featured Cape Cod Entry Systems in this Catalog



PL224-109C
pg 60



PL106-308C
pg 62

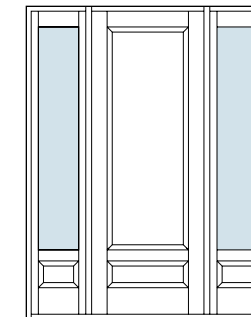

TS2210-105C
pg 63

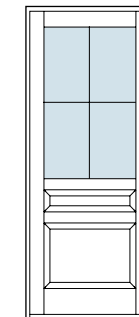

PL224-101
pg 64

Other Featured Cape Cod Entry Systems

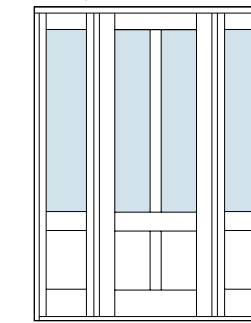

TS4140-105C
pg 75

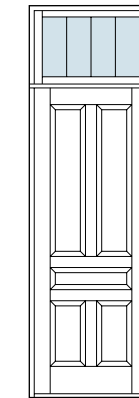

TS5060-104D
online



PL109-109C
online

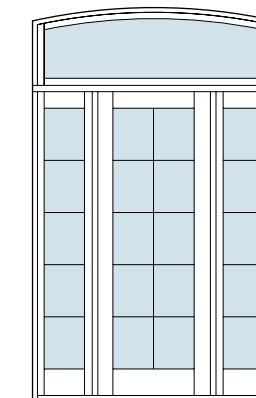

FL1000-308C
online

See more door style options on pages 68-75.

Entry System Layouts

Begin every project by selecting your entry system layout. From a single door, or a door and one sidelite, to a pair of doors with matching sidelites and transoms, this key will get you off to the right start.

SINGLE DOOR SYSTEMS

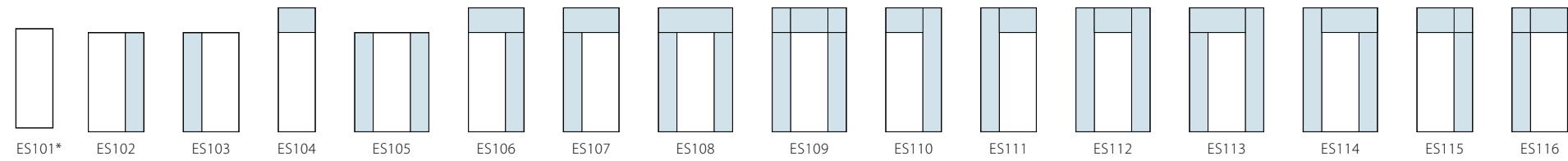

PAIRED DOOR SYSTEMS

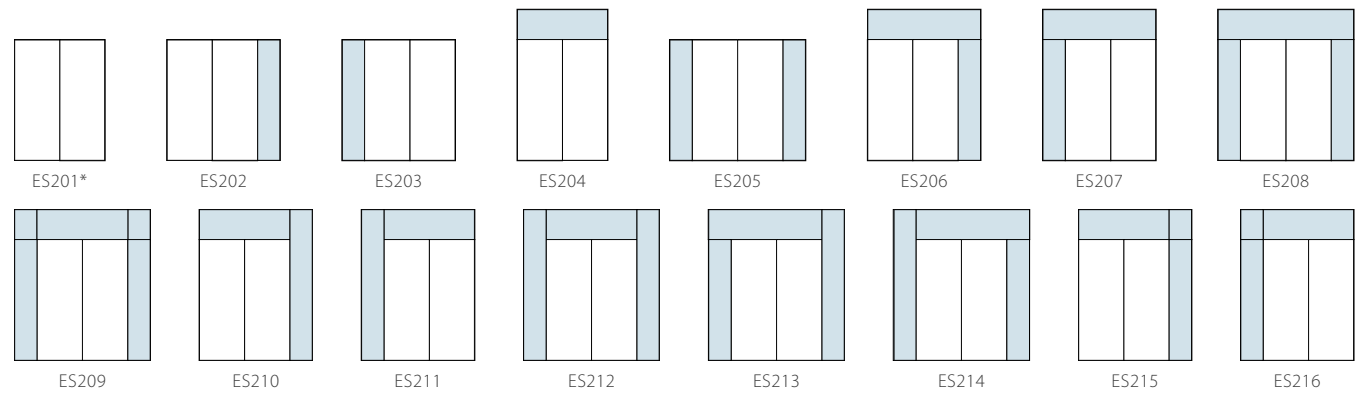

ARCH- AND RADIUS-TOP SYSTEMS**

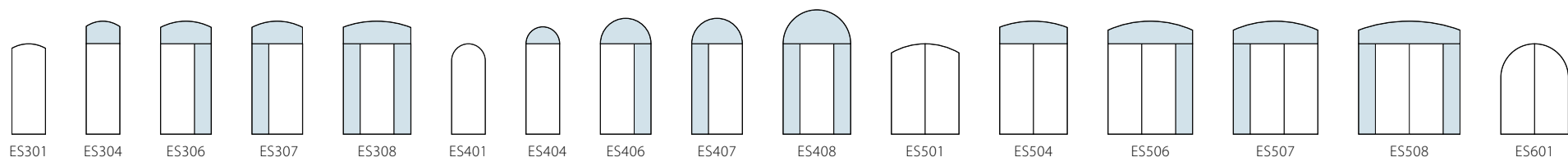

*ES101 and ES201 are available for TruStile Resilient™ Wood Entry Systems with no overhang applications.

**Arch- and radius-top systems are only available on TruStile Reserve™ Wood Entry Systems. VG door styles not available with radius or arch tops.





TruStile Reserve™ TMIR5101-103B
Mahogany with Slate finish, 1/4" Kerf Cut Reveal, and White Lami Glass.

TRU&MODERN SERIES

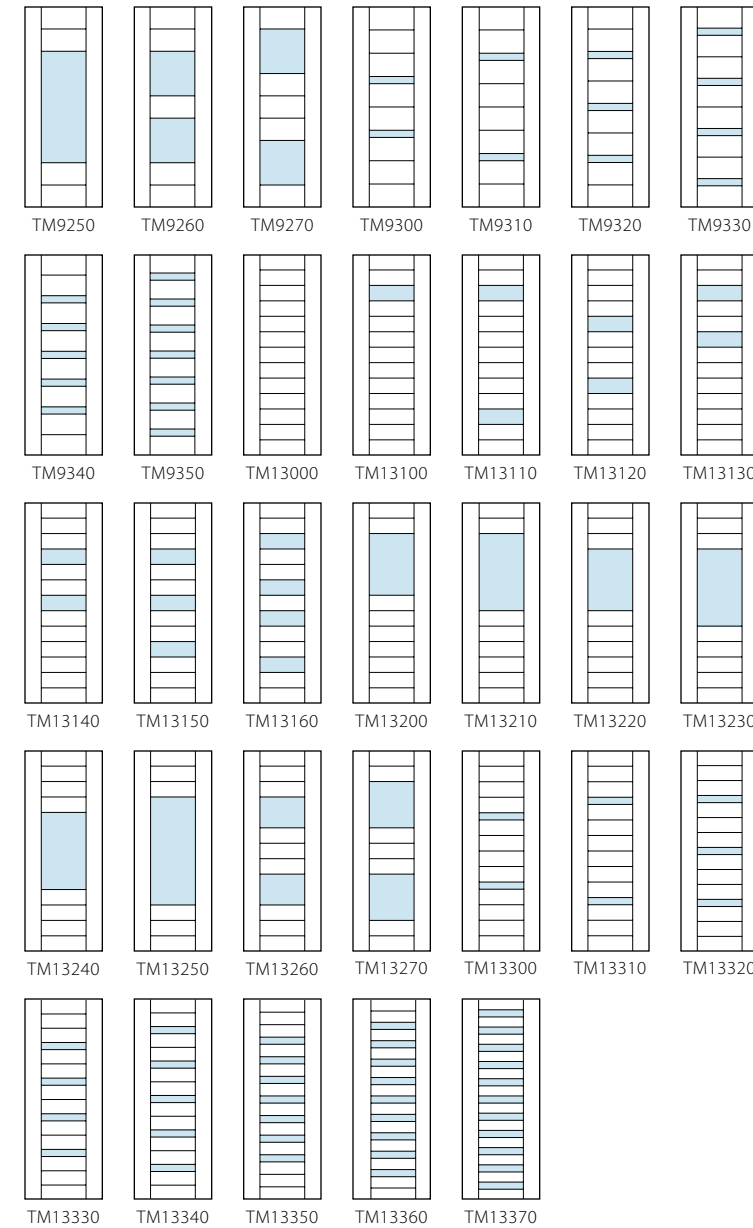

TRU&MODERN FLUSH SERIES

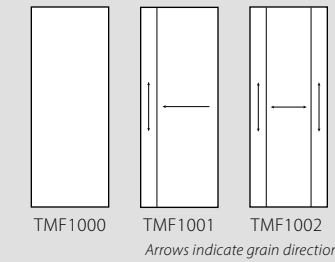

TRU&MODERN PLANK SERIES

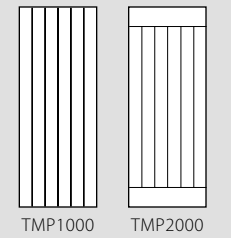

TRU&MODERN INFINITE RAIL SERIES

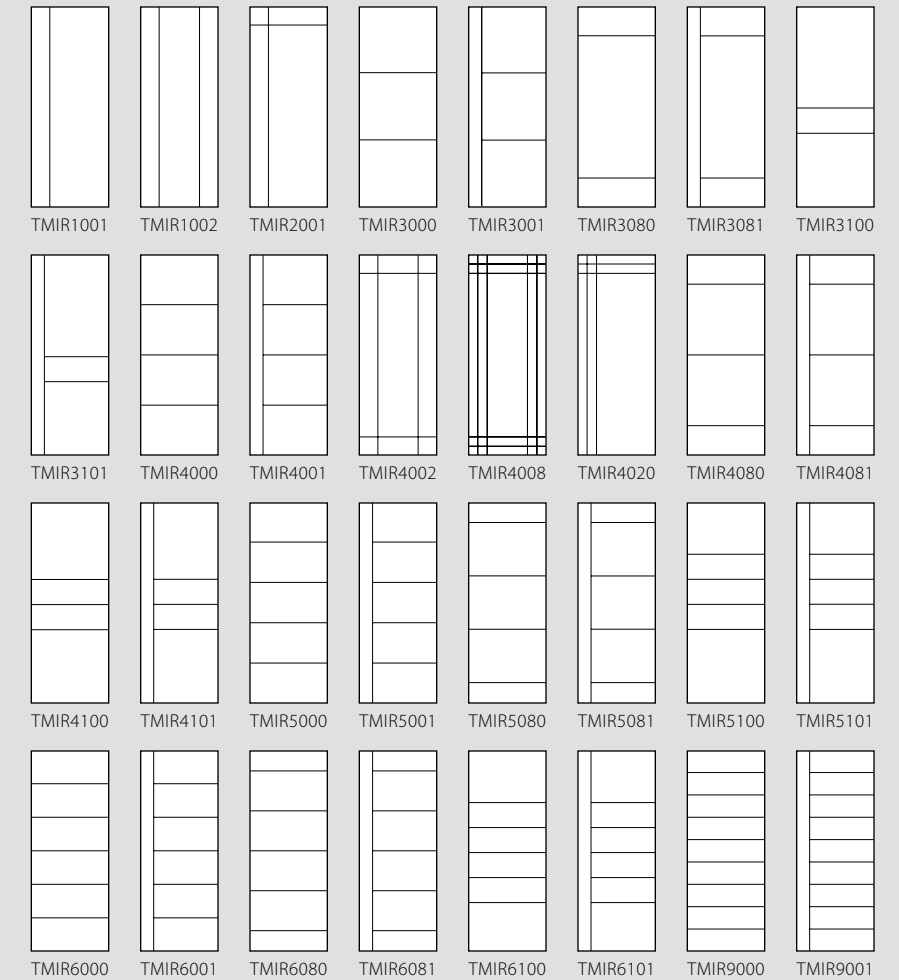



FRENCH LITE SERIES

FL100	FL101	FL102	FL103	FL110	FL111	FL112	FL113	FL200
FL210	FL260*	FL262*	FL300	FL301	FL302	FL304	FL305	FL306
FL310	FL314	FL315	FL316	FL360*	FL362*	FL400	FL401	FL410
FL411	FL420	FL421	FL430	FL431	FL440	FL450	FL460*	FL462*
FL500	FL501	FL510	FL511	FL520	FL521	FL530	FL531	FL560*

**These styles only available as sidelites.*

FL562*	FL563*	FL600	FL601	FL602	FL603	FL606
FL607	FL608	FL609	FL616	FL617	FL618	FL619
FL800	FL810	FL820	FL821	FL830	FL831	FL840
FL841	FL850	FL900	FL901	FL1000	FL1001	FL1010
FL1011	FL1020	FL1021	FL1030	FL1040	FL1041	FL1200

FL1210	FL1220	FL1221	FL1230	FL1231	FL1240	FL1241	FL1250
FL1300	FL1310	FL1400	FL1500	FL1501	FL1510	FL1511	FL1520
FL1521	FL1530	FL1531	FL1540	FL1800	FL1801	FL1810	FL1811
FL1820	FL1821	FL1830	FL1831				

TruStile Resilient™ FL400-108C
See page 31 for complete specs.

PANEL LITE SERIES



TruStile Resilient™ PL224-101
 See page 64 for complete specs.

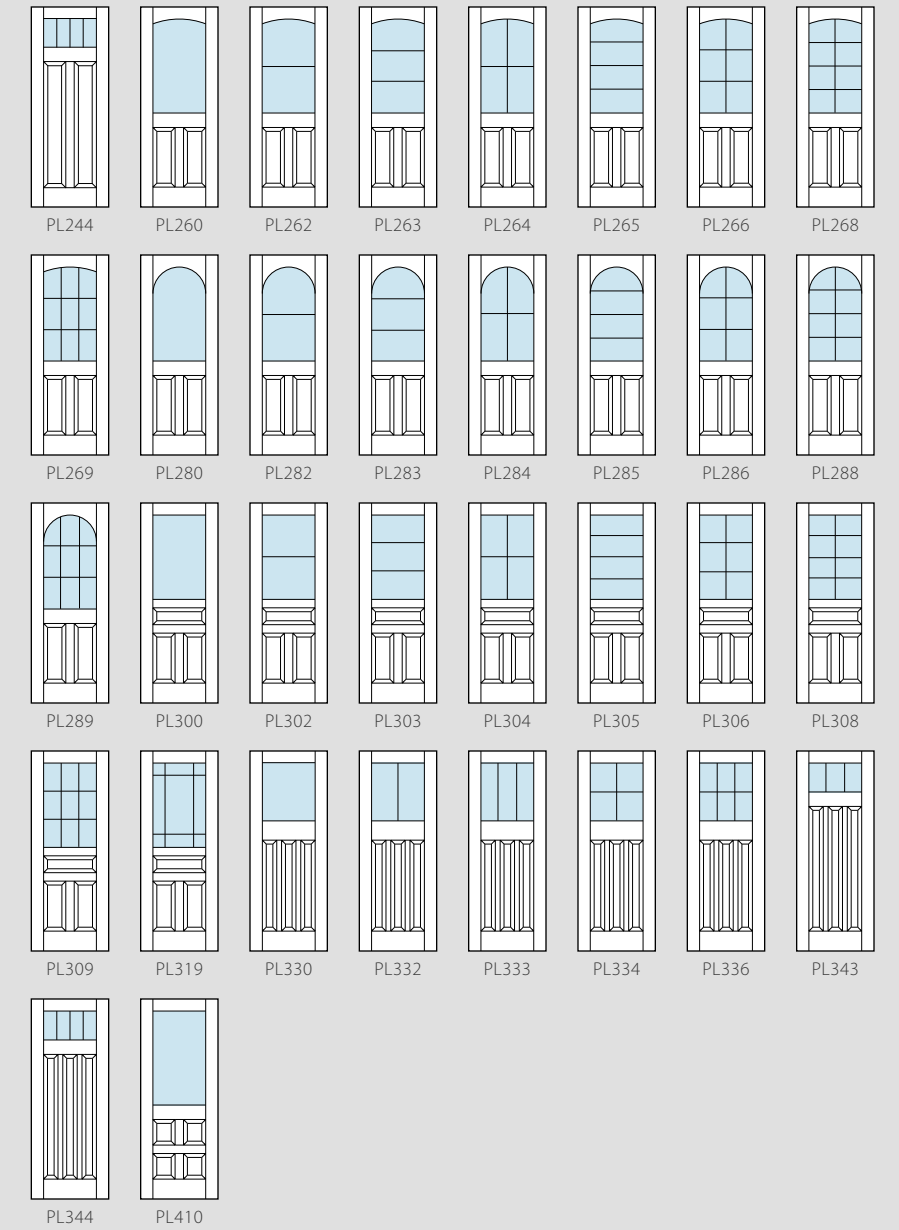

TRUSTILE SERIES

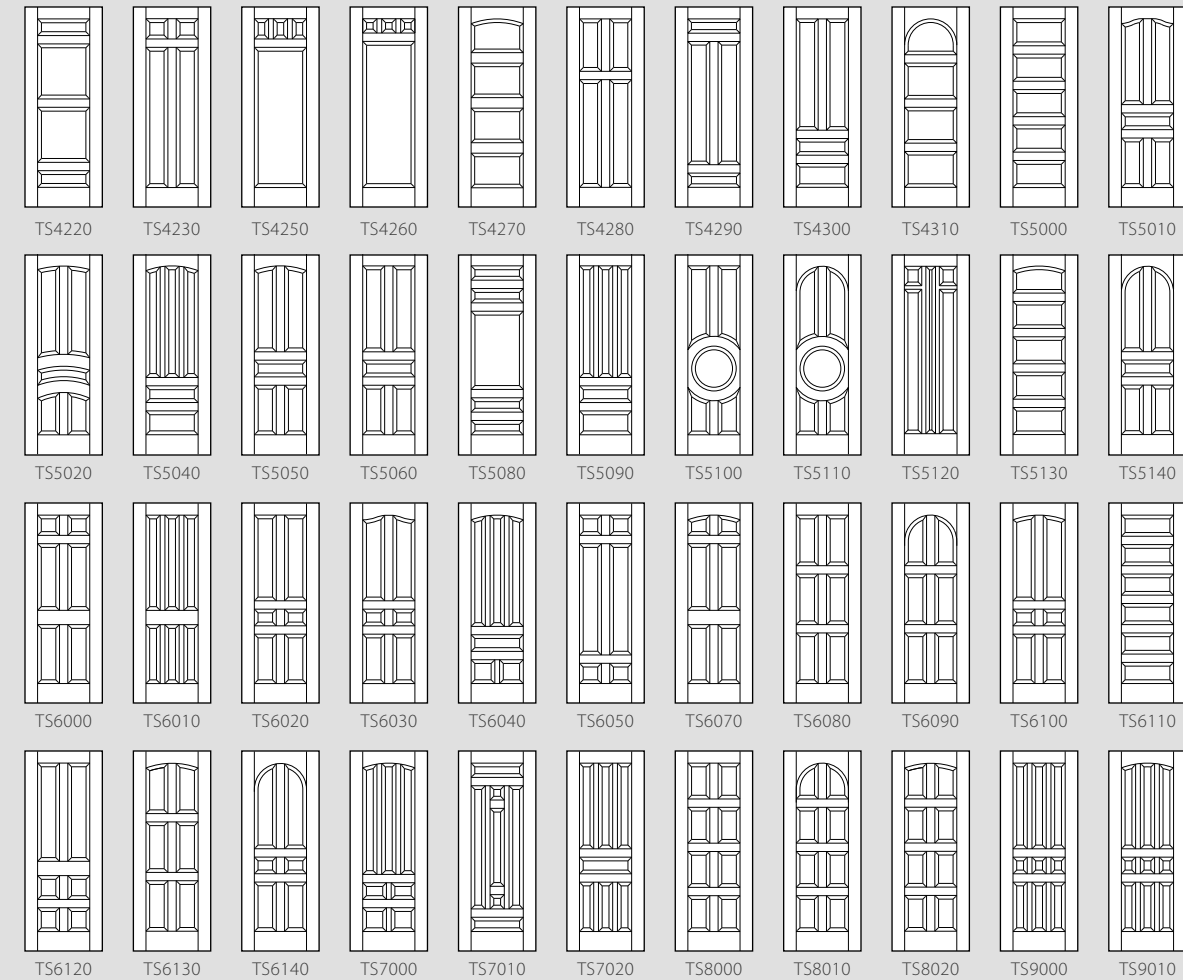
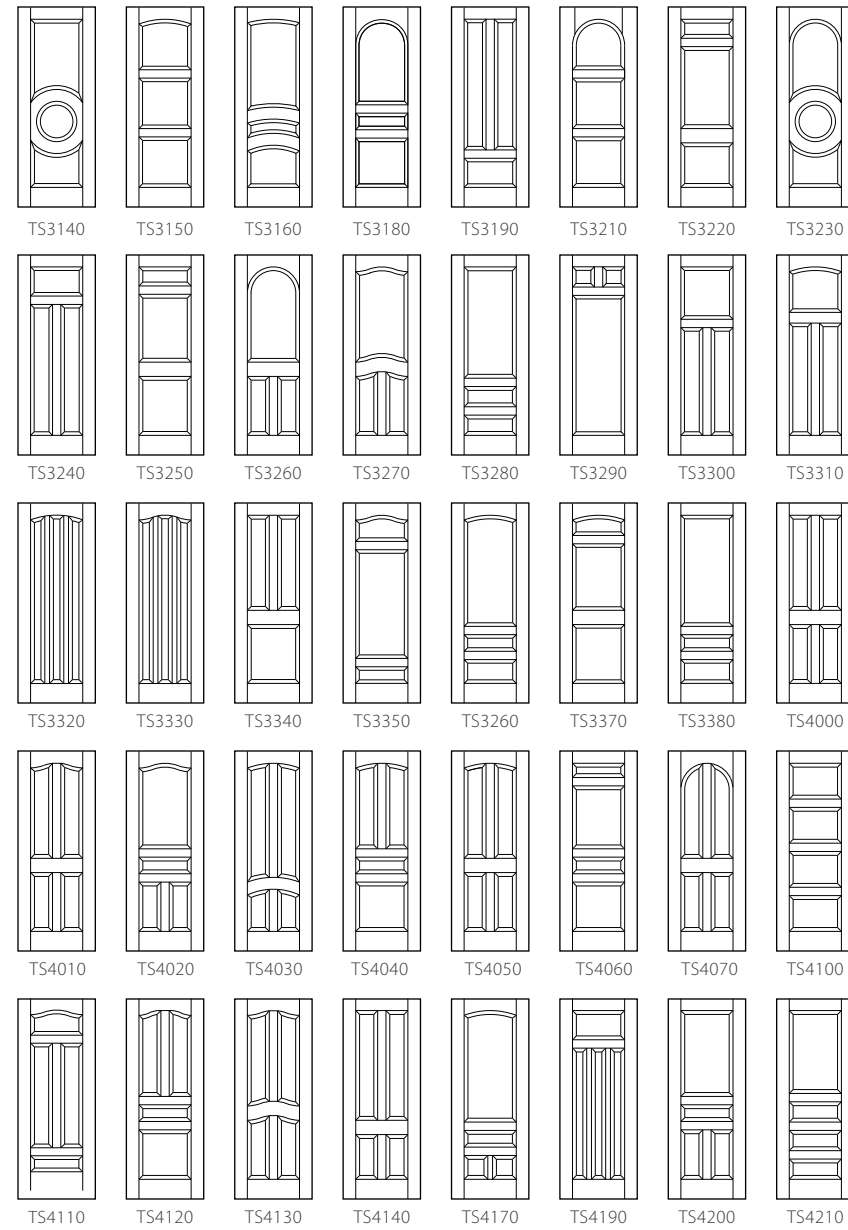
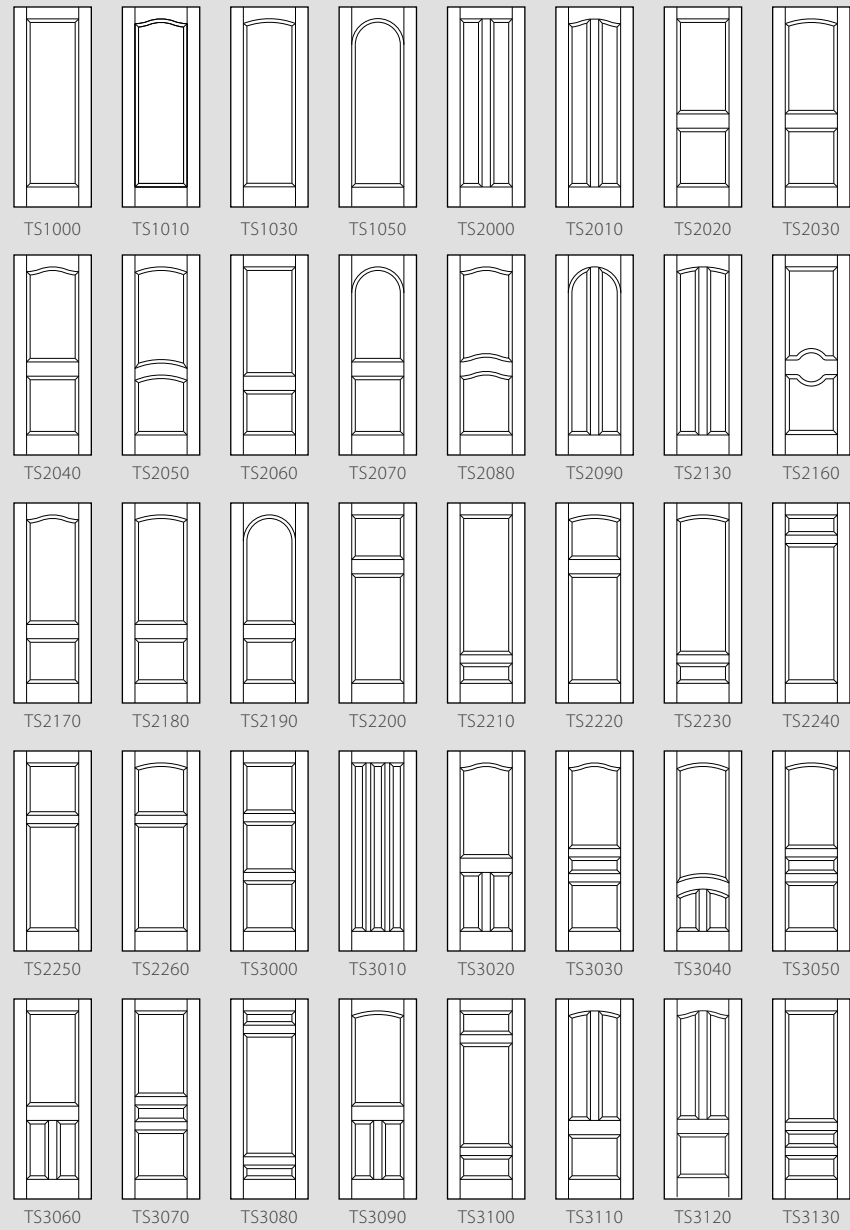

V-GROOVE SERIES

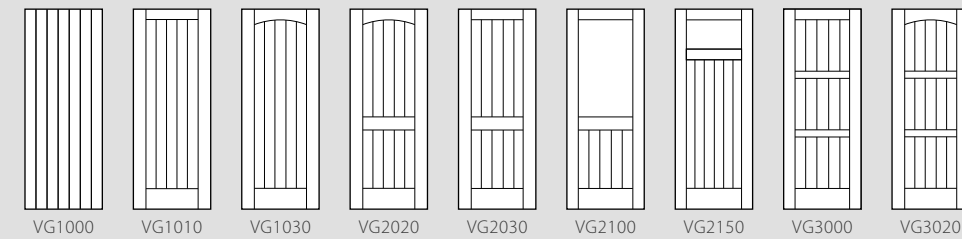

TruStile Resilient™ TS3070-201
 See page 23 for complete specs.



TruStile Reserve™ TS4140-105C with PL100 Sidelites.

Transoms

Select from this extensive collection of transoms to complement your entry door.



IN-SASH SQUARE TRANSOMS



ARCH- AND RADIUS-TOP TRANSOMS



DIRECT SET SIDELITES AND TRANSOMS

Sidelites

Select from this extensive collection of sidelites to complement your entry door. Many panel doors are available with glass options.



ONE-LITE IN-SASH SIDELITES



COMPLEMENTARY SIDELITES



MATCHING DOOR SIDELITES

Available in 1- to 18-lites.

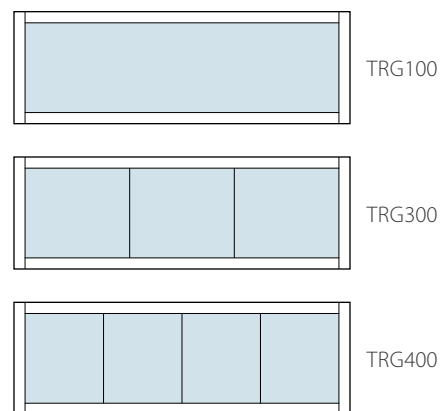

Available only for TruStile Reserve™

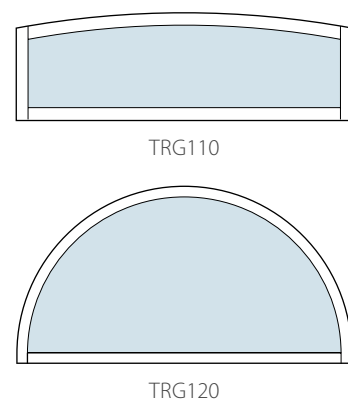

Maximize the amount of natural light available.

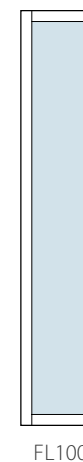
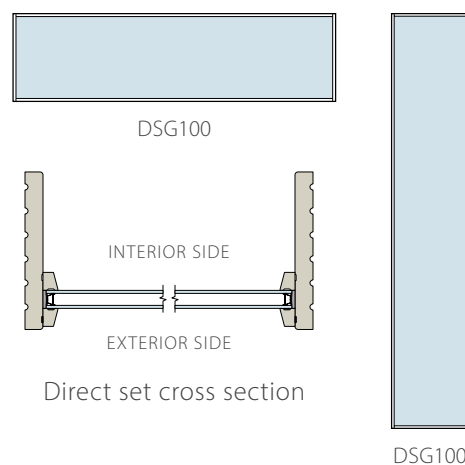

A one-lite in-sash sidelite is a classic look that brings natural light into your entrance.

Order sidelites with stiles and rails as narrow as 1-7/8".

We offer a wide selection of sidelites to complement your door style.

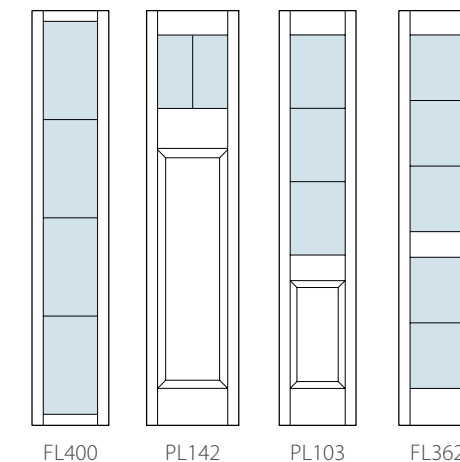

Many door styles are available as a matching sidelite.

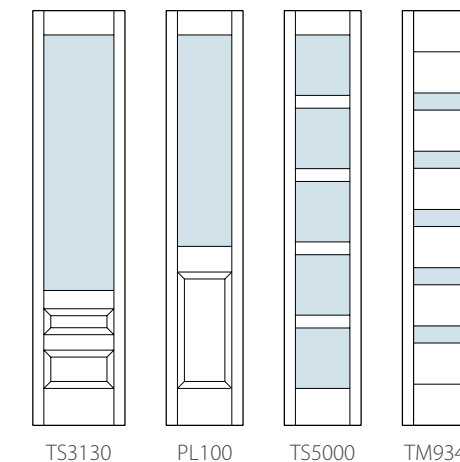



Resilient™ and Reserve™ Wood Entry Systems Construction

In collaboration with our parent company, Marvin™, we have engineered a family of premium entry systems that don't just transform a space, but how you feel inside it.

TruStile Entry Systems have been extensively tested and proven in partnership with the Marvin™ Research and Development team.

Reserve™ Wood Entry System

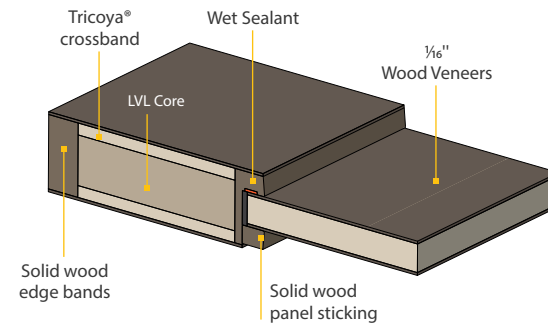

Resilient™ Wood Entry System

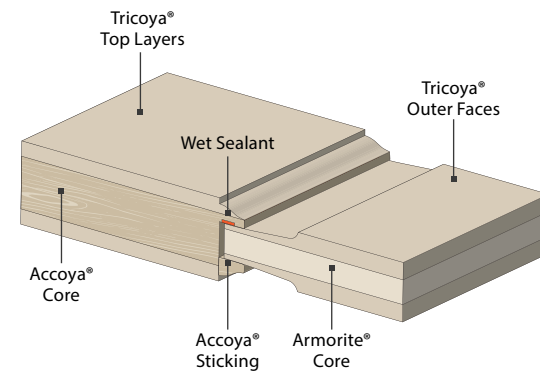

Wood Performance Every Home Can Rely On

Learn more about the innovative, durable materials used in making our entry systems.



As the sister brand to Accoya®, Tricoya® is an acetylated wood panel product that achieves the same ultra-high levels of durability and stability in the most extreme and challenging climates and outdoor applications. Tricoya is used as a stable core material within the Reserve™ Wood Entry system and a durable, paintable surface layer of our Resilient™ Entry system.

- Doesn't shrink or swell like other wood products
- Superior paintability and consistent surface across the entire door
- Complies with CARB 93120 for No Added Formaldehyde



Accoya® is an acetylated, modified wood product that is unsurpassed when it comes to durability, stability and withstanding the test of any climate.

As part of the TruStile Resilient™ Entry System, Accoya® is used for the core and frame components for durability, stability, and superior rot resistance.

- Doesn't shrink or swell like other wood species
- 100% real wood. A sustainable and durable material
- Solid wood core provides superior screw holding on door edge



So, What is Acetylation?

Acetylation is a process used to enhance the naturally-occurring properties of wood. In simple terms, it 'pickles' the wood, reducing how much water the cells in the wood can absorb.

It does this without adding toxic chemicals to the final product, but by boosting the concentration of 'acetyl groups' — which are already found naturally in trees and their wood.

More specifically, the process uses acetic anhydride to change hydroxyl groups (which like water) into acetyl groups (which don't like water), resulting in improved performance characteristics without introducing harmful or environmentally unfriendly additives.

Altogether, this means the wood shrinks and swells much less when wet, and is much less susceptible to decay or insect attack. The finished product is highly durable and dimensionally stable, outperforming all known species of wood.

Profile Options

Panel Profiles

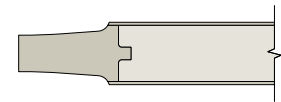

Raised (A) Panel

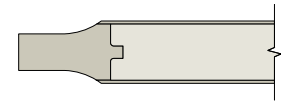

Scoop (B) Panel
Also available with bladder-press panel



Flat (C) Panel

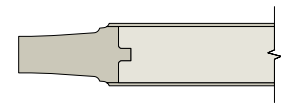

Double Hip (D) Panel

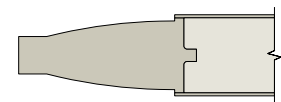

Senior Raised (E) Panel

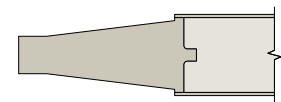

Senior Bevel (F) Panel

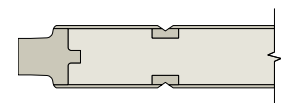

Standard V-Groove (VG) Panel

Sticking Profiles

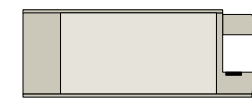

Square Stick (SS) Sticking

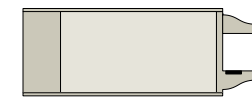

Roman Ogee (OG) Sticking

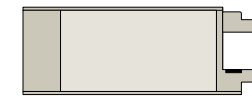

One Step (OS) Sticking

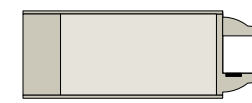

Quarter Bead (QB) Sticking

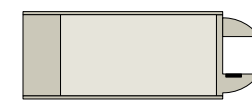

Quarter Round (QR) Sticking

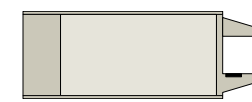

Bevel (BV) Sticking

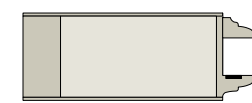

Cove & Bead (CB) Sticking

Applied Mouldings

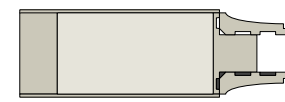

Cove (CV) Applied Moulding

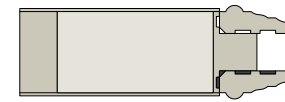

Low Profile Bolection (LP) Moulding

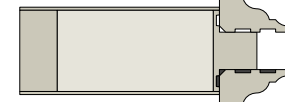

Bolection (BM) Moulding



Big Bolection (BB) Moulding

Simulated Divided Lite Bars (SDL)

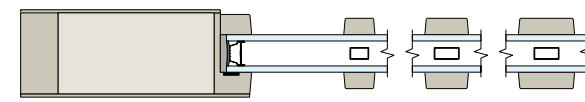

Square Stick (SS) SDL Glass 5/8" 7/8" 1-1/8"

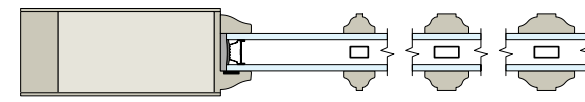

Roman Ogee (OG) SDL Glass 5/8" 7/8" 1-1/8"

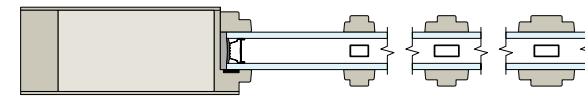

One Step (OS) SDL Glass 5/8" 7/8" 1-1/8"

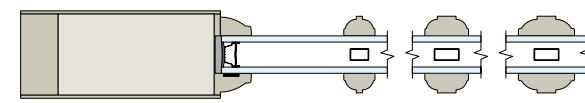

Quarter Bead (QB) SDL Glass 5/8" 7/8" 1-1/8"

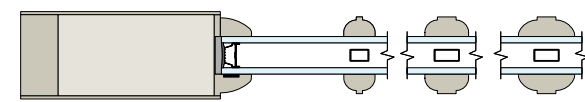

Quarter Round (QR) SDL Glass 5/8" 7/8" 1-1/8"

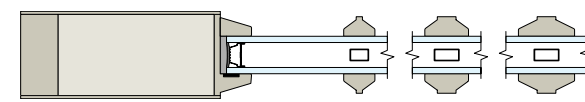

Bevel (BV) SDL Glass 5/8" 7/8" 1-1/8"

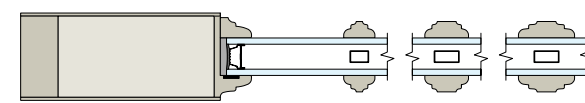

Cove & Bead (CB) SDL Glass 5/8" 7/8" 1-1/8"

True Divided Lite Bars (TDL)

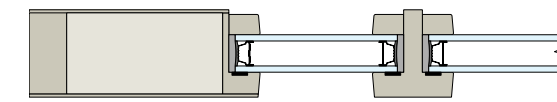

Square Stick (SS) TDL Glass 1-5/8"

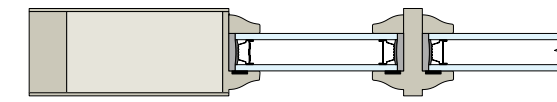

Roman Ogee (OG) TDL Glass 1-5/8"

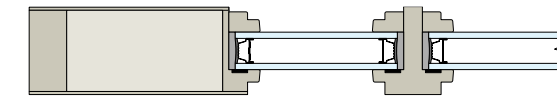

One Step (OS) TDL Glass 1-5/8"

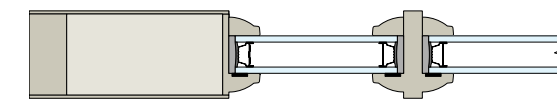

Quarter Bead (QB) TDL Glass 1-5/8"

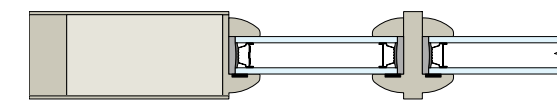

Quarter Round (QR) TDL Glass 1-5/8"

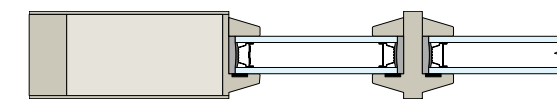

Bevel (BV) TDL Glass 1-5/8"

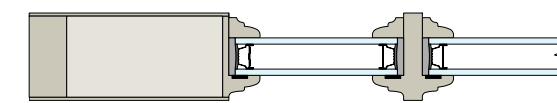

Cove & Bead (CB) TDL Glass 1-5/8"

Frame Profile and Mull Construction

All Reserve™ frame parts undergo a wood dip treatment to protect against fungus and insects. Resilient™ frames don't require dipping.

FRAME OPTIONS

UNIFRAME MULL POST OPTIONS

Single Rabbet Frame with Back-to-Back Mull Posts

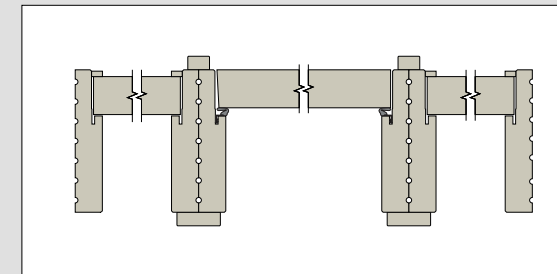

Default for all door applications

Single Rabbet Frame with 4 9/16" Uniframe Mull Posts

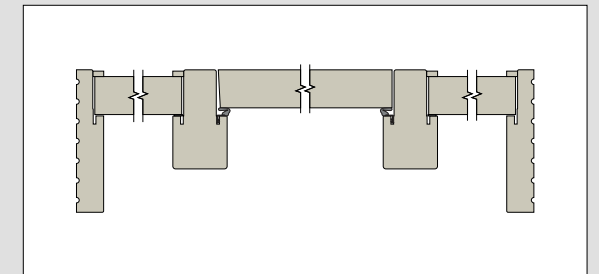

Double Rabbet Frame with Back-to-Back Mull Post

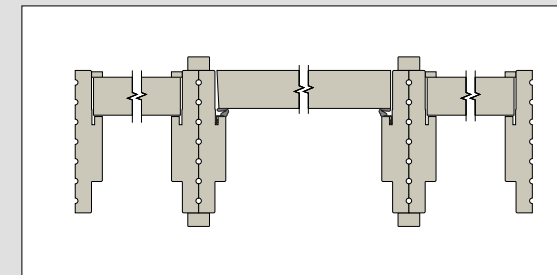

Accommodates screen door applications

Single Rabbet Frame with 6 3/16" Uniframe Mull Posts

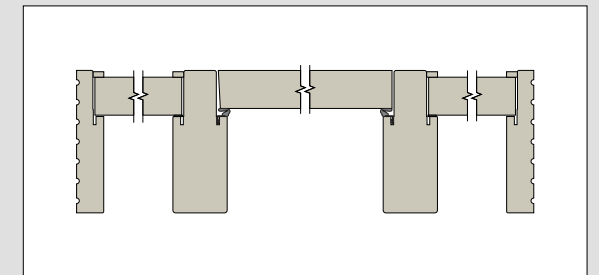

Double Rabbet Frame, Uniframe, and Screen Doors are available in Reserve™ only

Wood Species for Reserve™ Entry Systems

The Reserve™ Wood Entry System elevates the refined elegance of your home with the beauty of stained natural wood. Available in 10 natural wood species with an extensive collection of premium factory stain options.



Mahogany



Genuine Mahogany



Cherry



Douglas Fir (Vertical Grain)



Select Alder

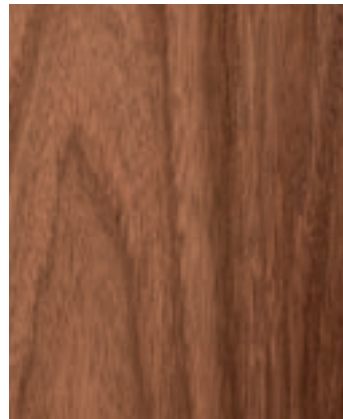

Walnut

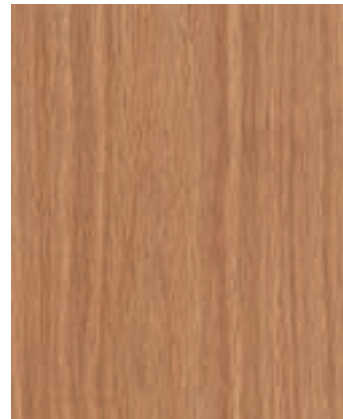

Plain Sawn White Oak



Quarter Sawn White Oak



Rift Sawn White Oak



Clear Pine

Paint-Grade Mahogany and Paint-Grade Douglas Fir not shown.



Consider the Resilient™ Wood Entry System for paint-grade applications.

Stain Options

TruStile uses stains from ICA, a leading European finish manufacturer, for factory-finished entry systems. We begin by applying either a clear or tinted base stain with UV inhibitors (unfinished doors also get this base coat). Then a total of five coats of finish are applied. This includes two seal coats and three topcoat layers of finish giving a robust dry film finish thickness. Slight color and sheen differences might occur between interior and exterior finishes.

	Amaretto	Bleached	Cameo	Cappuccino	Caramel	Champagne	Cinnamon	Ebony	Espresso	Grey Mist	Hazelnut	Honey	Nutmeg	Slate	White Haze
Mahogany	[Sample]	[Sample]	[Sample]	[Sample]	[Sample]	[Sample]	[Sample]	[Sample]	[Sample]	[Sample]	[Sample]	[Sample]	[Sample]	[Sample]	[Sample]
Cherry	[Sample]	[Sample]	[Sample]	[Sample]	[Sample]	[Sample]	[Sample]	[Sample]	[Sample]	[Sample]	[Sample]	[Sample]	[Sample]	[Sample]	[Sample]
Clear Pine	[Sample]	[Sample]	[Sample]	[Sample]	[Sample]	[Sample]	[Sample]	[Sample]	[Sample]	[Sample]	[Sample]	[Sample]	[Sample]	[Sample]	[Sample]
Douglas Fir	[Sample]	[Sample]	[Sample]	[Sample]	[Sample]	[Sample]	[Sample]	[Sample]	[Sample]	[Sample]	[Sample]	[Sample]	[Sample]	[Sample]	[Sample]
Select Alder	[Sample]	[Sample]	[Sample]	[Sample]	[Sample]	[Sample]	[Sample]	[Sample]	[Sample]	[Sample]	[Sample]	[Sample]	[Sample]	[Sample]	[Sample]
Walnut	[Sample]	[Sample]	[Sample]	[Sample]	[Sample]	[Sample]	[Sample]	[Sample]	[Sample]	[Sample]	[Sample]	[Sample]	[Sample]	[Sample]	[Sample]
White Oak	[Sample]	[Sample]	[Sample]	[Sample]	[Sample]	[Sample]	[Sample]	[Sample]	[Sample]	[Sample]	[Sample]	[Sample]	[Sample]	[Sample]	[Sample]

For White Oak: Choose rift sawn, plain sawn or quarter sawn. Plain sawn White Oak shown.

The color of the finish can vary depending on the color of the wood, lighting on the job site, and natural exposure to oxidation and sunlight. To get the best example of the stain color on a specific species, please visit your TruStile dealer.

Hinge Options

Choose from ten standard hinge finishes or select an option from Emtek® or Baldwin®.

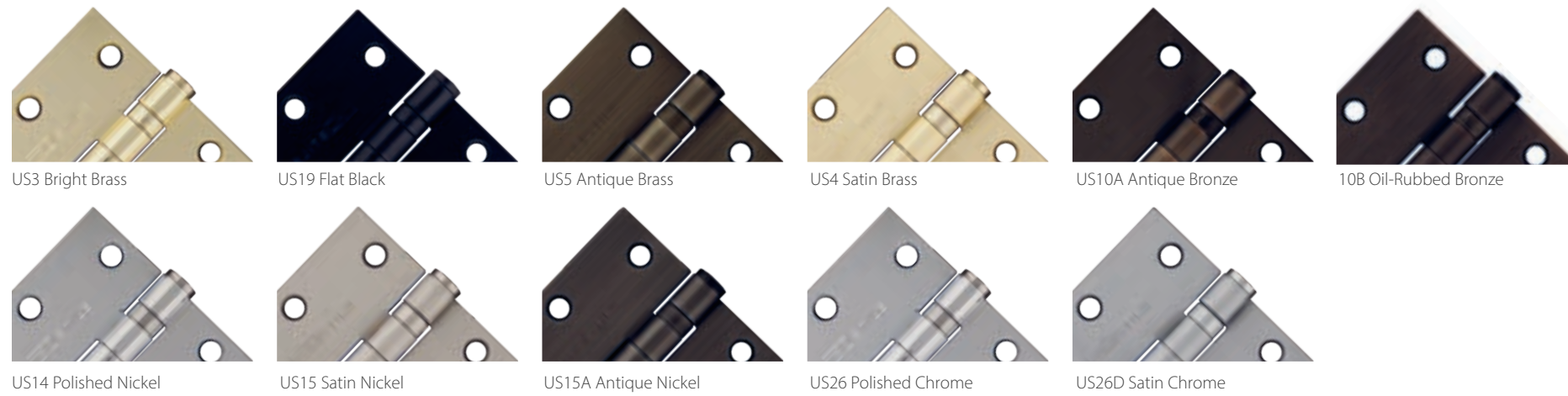

Sill Options

Choose from one of five standard sill options to complete your entry system.

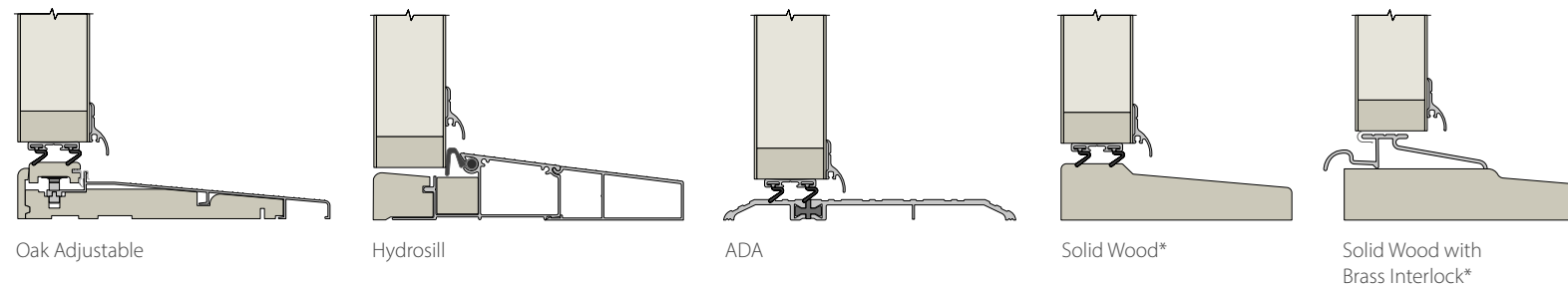

** Only available on TruStile Reserve™ Wood Entry Systems. Solid Wood Sills available in Genuine Mahogany and Plain Sawn White Oak.*

Multipoint Lock Option

TruStile offers an automatic locking system from GU-Security which is required for certain warranty coverage. See website for details. trustile.com/entry-systems/resources

Insulated Glass Options

Complete your grand entrance with one of our many insulated glass options, including LoE and several decorative patterns.

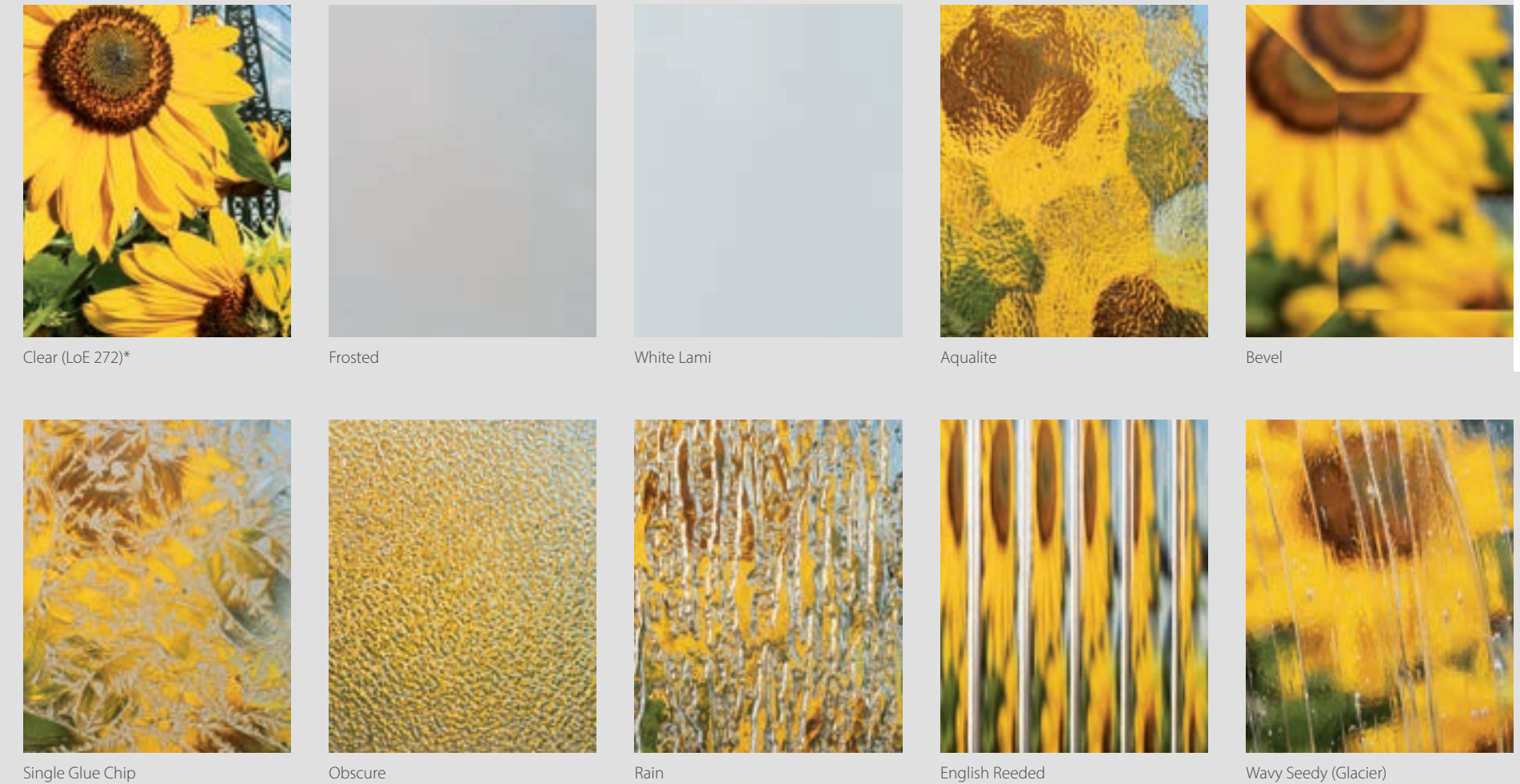

** Clear glass also available as LoE 366, LoE 340, LoE 180, Low Iron and Clear Lami.*

Comparison of Resilient™ and Reserve™ Wood Entry Systems

	Reserve™ Wood Entry Systems	Resilient™ Wood Entry Systems	Resilient™ Wood Entry Systems No Overhang Required
Door Style	Over 500 standard door styles	Over 500 standard door styles	Over 500 standard door styles
Maximum Door Size	42" x 120" Single unit 84" x 120" Pair unit (42" leaf)*	42" x 96" Single unit 84" x 96" Pair unit (42" leaf)*	42" x 96" Single unit 72" x 96" Pair unit (36" leaf)*
System Layouts	All options available	All options available, except arched or radius top	ES101 and ES201 only
Finish	Factory prime, stained finish or user applied	Factory primed for field applied paint	Factory primed for field applied paint
Overhang Requirements	Industry standard overhang requirements**	Reduced overhang requirements**	No overhang requirements**
Limited Warranty	5 year factory primed or finished; 3 year unfinished***	10 year***	10 year***
Maintenance	Top coat finish should be inspected annually and re-applied as needed	Painted finish should be inspected annually and re-applied as needed	Painted finish should be inspected annually and re-applied as needed
Dark Finishes/Paint	Not warranted for door movement	Warranted when ordered with factory multi-point lock	Warranted when ordered with factory multi-point lock
Wood Screen/Storm Door	Available	Not available	Not available
Sills	Five different sill options available	Three different sill options available	Hydrosill™
Multipoint Lock	GU-Secury Automatic multipoint lock available	GU-Secury Automatic multipoint lock available	GU-Secury Automatic multipoint lock required for pairs

*As of January 2023; size minimums may expand. Visit trustile.com/construction/entry-door for latest offering.

Refer to page 87 for overhang requirements. *Additional requirements may apply, please refer to TruStile warranty.

Note: Exterior doors not available for commercial projects.

Industry-Leading Warranty Coverage

TruStile Wood Entry Systems come backed with industry-leading warranty coverage. Door systems that are factory finished by TruStile are warranted to be free from manufacturing defects for 5 years from date of purchase for the Reserve™ Wood Entry System and 10 years from date of purchase for the Resilient™ Wood Entry System depending on application and specifications. Door systems purchased raw and unfinished are warranted to be free from manufacturing defects for 3 years from date of purchase. Due to its aging characteristics, Alder door systems are warranted for 1 year from date of purchase. Please see trustile.com/warranties for specific detail warranty information for each product.

Requirements for Warranty Coverage

Your TruStile Entry Door should be viewed as a piece of well-engineered fine furniture. Careful steps have been taken to design the product to perform in proper exterior openings. However, finishes and natural wood both weather and break down over time. This weathering process increases with greater exposure to the elements. TruStile Wood Entry systems, like those sold by other manufacturers, require proper overhang protection to meet warranty requirements (see diagram below for details). Proper overhang helps to protect both the finish and the natural wood from moisture and UV damage. Even with proper overhang, the topcoat of any stained natural wood door must be inspected annually and reapplied during early signs of fading. Maintaining the topcoat will maximize the life of your natural wood door and is also required to maintain TruStile warranty coverage.

Overhang Requirements

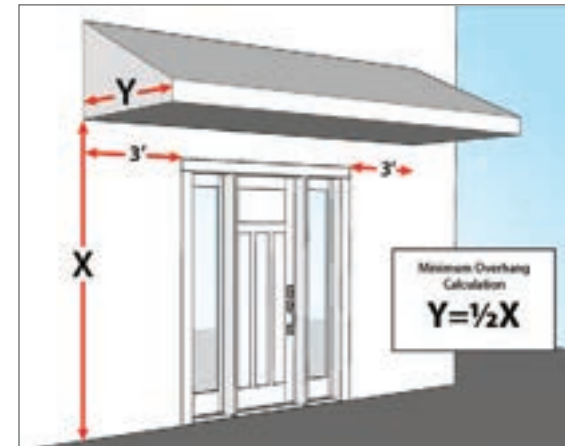

Standard Overhang

Required for Reserve™ Wood Entry System warranty coverage



Reduced Overhang

Required for warranty coverage on:

- Resilient™ Wood Entry System with sidelites and/or transoms
- Resilient™ single and pair units with oak adjustable sill
- Resilient™ pair units without multi-point locks

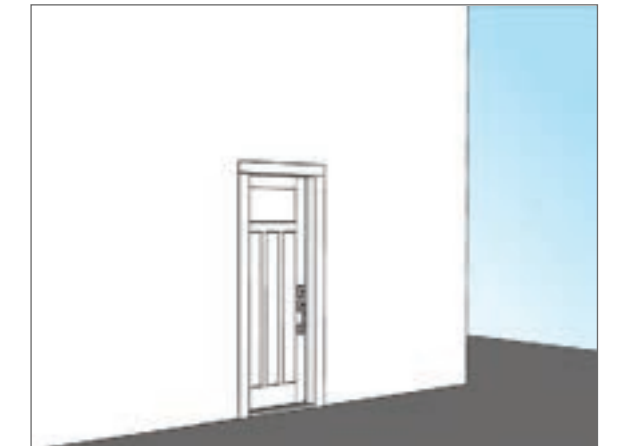

No Overhang Required

Warranty coverage available for Resilient™ single and pair units meeting the following:

- Hydrosill™ required
- 3'6" x 8'0" maximum single door width
- 6'0" x 8'0" maximum pair width
- Multi-point lock required for no overhang coverage on pairs

Door Design Tool

Configure multiple doors and organize them by project.

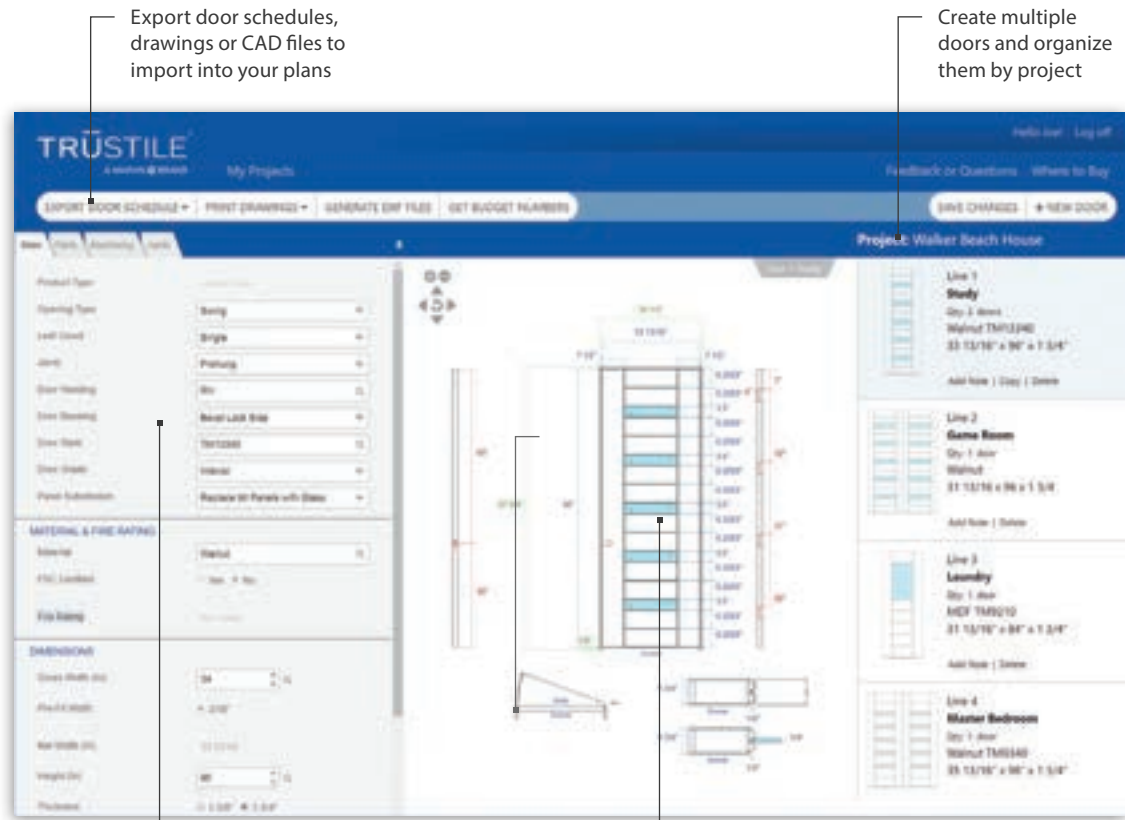

Export door schedules, drawings or CAD files to import into your plans

Create multiple doors and organize them by project

Over 500 door styles to customize to your needs — available as interior or exterior, pre-hung units or slabs.

An accurate preview is continually updated as you make changes to your door design.

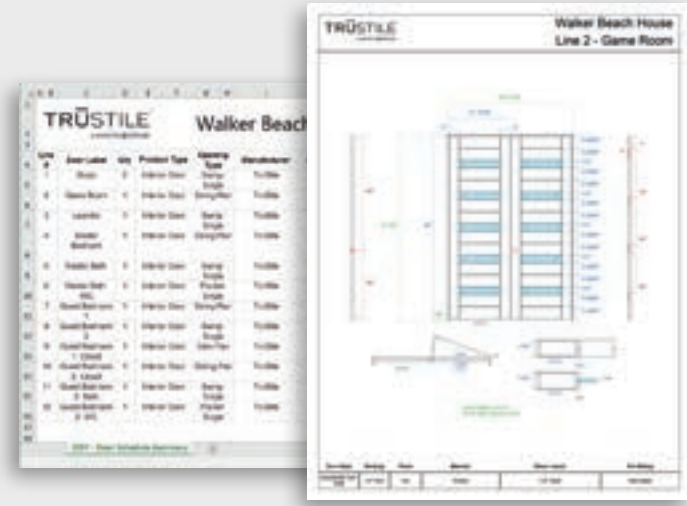

Share Your Project with Other Apps

Door Design Tool projects can be exported as a door schedule that opens directly in Microsoft® Excel, as a PDF of drawings or CAD models to import directly into your plans.

www.trustile.com/designtool



See page 45 for product specs.



[trustile.com](https://www.trustile.com)



1111 E 71st Avenue
Denver, CO 80229
877.283.4511